

*dCS Puccini Player*  
Upsampling CD / SACD Player

**User Manual**

Software Release 1.3x

June 2011

© Data Conversion Systems Ltd. 2007-2011

**Price UK £8.00 / Euro 12.00**

All rights reserved. No part of this publication may be reproduced, stored in or introduced into a retrieval system, or transmitted in any form, or by any means (electronic, mechanical, photocopying, recording or otherwise) without the prior written permission of *dCS*<sup>1</sup>. Any person who does any unauthorised act in relation to this publication may be liable to criminal prosecution and civil claims for damages.

Information contained in this manual is subject to change without notice, and whilst it is checked for accuracy, no liabilities can be accepted for errors.

---

<sup>1</sup> *dCS* is Data Conversion Systems Ltd. Company registered in England No. 2072115.



## Contents

<b>Using the dCS Puccini Player for the first time .....</b>	<b>4</b>
What's in the box?	4
Positioning the unit	4
Condensation	4
Safety Notice	5
Laser Radiation	5
Which types of disc can be played?	6
Which types of disc can NOT be played?	6
<b>Step-by-Step Guide .....</b>	<b>7</b>
Preliminaries	7
Fitting the Remote Control handset batteries	8
STEP 1 – Connecting the Analogue Outputs	9
STEP 2 – Playing a Disc	10
STEP 3 - Setting the Output Level	10
STEP 4 – Disc Playing Options	11
STEP 5 – Using a Master Clock	12
STEP 6 – Using an External Source	13
STEP 7 – Using the Digital Outputs	14
<b>Front Panel.....</b>	<b>15</b>
POWER Button	15
MENU Button	15
JOG BACK / FORWARD Buttons	15
STOP / EJECT Button	15
PLAY / PAUSE Button	16
PREVIOUS TRACK / NEXT TRACK Buttons	16
VOLUME ↑/↓ Buttons	16
Remote Control Receiver	16
Display	16
CD Tray	16
<b>Rear Panel.....</b>	<b>17</b>
Mains inlet	17
Analogue Outputs	17
Word Clock Input / Output	17
Digital Inputs	17
Digital Outputs	17
SUC Connector	17
<b>Remote Control.....</b>	<b>18</b>
<b>The Menu.....</b>	<b>19</b>
Using the Menu	20
INFORMATION Menu	21
SETTINGS Menu	22
SET-UP Menu	24
DISPLAY SETTINGS Menu	26
SIGNAL GENERATOR Menu	26
<b>Specification .....</b>	<b>27</b>
<b>Maintenance and Support .....</b>	<b>28</b>
Service and Maintenance	28
Replacing a Blown Mains Fuse	28
Cleaning the case	28
Limited Warranty	29
Operating Conditions	29
If you need more help	30
Software History	30

## USING THE *dCS Puccini Player* FOR THE FIRST TIME

Congratulations on purchasing your *dCS Puccini Player*.

Before using your unit, please read this section and the Step by Step Guide. This will enable you to set the unit up quickly and safely with your hi-fi system.

From time to time, *dCS* will release updated software on CD that you can install yourself using the **CD Update** feature. Please check our web-site occasionally to see if new *Puccini Player* software is available, or consult your dealer.

### What's in the box?

Check that the box contains the following items:

- *dCS Puccini Player*
- Manual and Menu Guide
- Power cable
- 2 spare fuses
- Remote Control with 2x AAA batteries

Notify your dealer as soon as possible if anything is missing or damaged. We suggest that you retain the original packaging for possible future use. If this is not possible, replacement packaging can be ordered from *dCS* or our distributors. Details can be found on our web site at [www.dcsLtd.co.uk](http://www.dcsLtd.co.uk).

The cables supplied are commercial-grade parts, as we realise our customers will want to make their own choices.

### Positioning the unit

Place the unit on a firm, vibration free base, allowing convenient connection to the other parts of your system. To prevent overheating, we recommend that you leave some free space around the unit to allow for ventilation.

3 feet are fitted as standard, this may be changed to the 4-foot arrangement shown below, if you prefer. Spare feet are available as an optional extra. The mounting points are M4 size, maximum screw depth is 10mm.

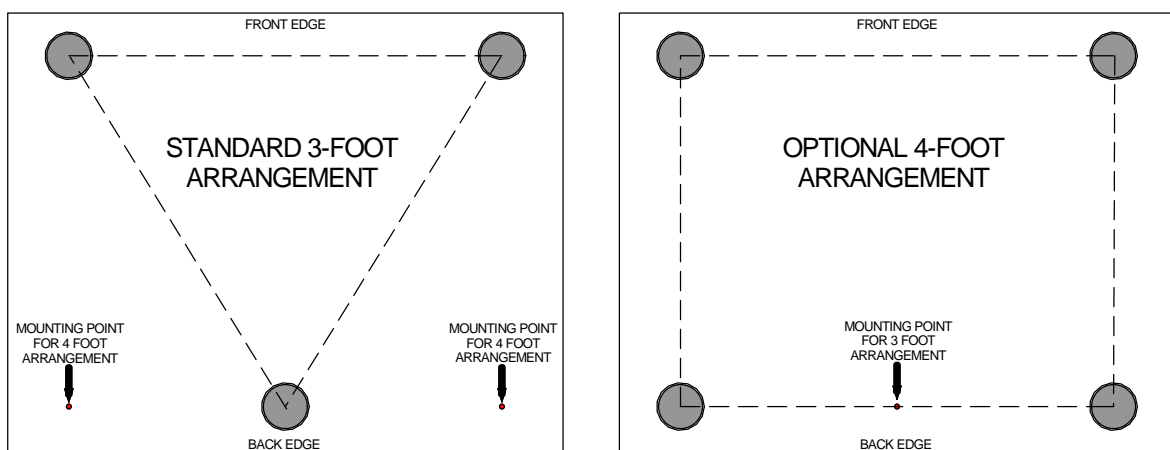

### Condensation

If the Player is cold and is moved into a warm room, condensation will form inside the unit. This interferes with normal operation. Remove the Player from its packaging and let it stand for 1 - 2 hours, to allow it to reach room temperature and the condensation to evaporate.

## Safety Notice



Your *dCS Puccini Player* contains no user serviceable parts. **DO NOT** attempt to open the case as there are potentially dangerous voltages present inside. In the event of the unit developing a fault, please contact your dealer in the first instance.

To maintain protection from electric shock, the unit **MUST** be connected to mains earth (ground) via the power cable. Also, unearthed systems do not give the best sonic performance.



This product is lead-free to comply with the RoHS directive.

Before connecting the power cable to the unit for the first time, please check that it has been set to the correct operating voltage for your mains supply. The unit's voltage setting is shown on the serial number label. If this does not match your local supply voltage, **DO NOT** attempt to use the unit. Contact your dealer to have the unit reset. Using the unit with the wrong mains setting for your local supply may result in serious damage to the unit and will invalidate the warranty. Do not attempt to reset the voltage yourself.

We do not recommend the use of mains regenerators. However, if you do wish to use a mains regenerator with variable voltage and frequency, we recommend that you set the voltage to match your local voltage and the frequency to either 50Hz or 60Hz **ONLY**.



Damage caused to your *Puccini Player* by misuse of a mains regenerator or by a malfunctioning mains regenerator is not covered by the warranty.



Disposal at end-of-life - the symbol indicates that this product should not be treated as normal household waste. It should be recycled, so please take it to an approved collection facility.

## Laser Radiation



*dCS Puccini Player* is a Class 1 Laser Product, it complies with U.S. FDA 21CFR subchapter J. In normal use, there is no risk of exposure to laser radiation.



The case should only be opened by authorised service personnel. The case protects the user from indirect exposure to visible and invisible laser radiation, as well as risk of electric shock.

## Which types of disc can be played?



Commercially manufactured CDs can be played if they:

- are 12cm or 8cm round discs
- are recorded with linear PCM digital audio data
- carry the Compact Disc Digital Audio logo and meet the “Red-Book” standard.



Commercially manufactured single-layer SACDs or hybrid SACD/CD discs can be played if they:

- are 12cm or 8cm round discs
- are recorded with DSD digital audio data on the SACD layer
- carry the Super Audio CD logo and meet the “Scarlet-Book” standard.

**CD-R** CD-R or CD-RW discs recorded with audio data in CD format may be playable, but this depends on the disc, the software and the burner used to record on the disc.

**CD-RW** *dCS* cannot accept responsibility for any difficulty encountered while attempting to play such discs.

## Which types of disc can NOT be played?

*dCS* cannot accept responsibility for any difficulty encountered while attempting to play the following types of disc:

- Scratched, damaged or dirty discs.
- Printed or labelled CD-Rs or discs contaminated with glue or other sticky substances. These may get stuck inside the unit. If this happens, a service charge will be made for removing such discs.
- DVD, CD-G, CD-EXTRA, PHOTO CD, CD-ROM or DVD-ROM.
- Copy-protected discs that do not conform to the “Red-Book” CD standard may not play correctly or may not play at all. Such discs are not CDs – they are optical discs that have been recorded with digital audio data. They should not carry the Compact Disc Digital Audio logo – but some do. If you encounter any difficulty playing such discs, please contact the disc manufacturer and demand a genuine CD in exchange.

## STEP-BY-STEP GUIDE

This section guides you through setting up the unit for basic operation.

### Preliminaries

The Menu / Setup Guide sheet details the menu structure and details the two most common set-ups.

For digital interfaces, use with cables designed for digital audio:

- for Word Clock interfaces, use 75Ω coax cables fitted with BNC plugs.
- for SPDIF RCA interfaces, use 75Ω coax cables fitted with RCA Phono plugs.

For analogue outputs, use with screened cables of the correct type:

- for balanced outputs, use screened, twisted pair cables fitted with one male XLR connector and one female XLR connector.
- for unbalanced outputs, use coax cables fitted with RCA Phono plugs.

Connect the power cable supplied to the power inlet on the Player rear panel, plug the other end into a convenient power outlet.



Please do not use an excessively heavy or inflexible power cable as this may damage the power inlet connector.

Set the rear panel power switch to the **I** position. Briefly press the **Power** button and wait about 30 seconds while the Transport configures itself. The display will show in sequence: **Puccini, Welcome, Loading** and **No Disc**.

If the unit is likely to be set in an unfamiliar state, you can reset it as follows.

- Press the **Menu** button, press the **▶||** button once, then the **Menu** button again to display the **Player Settings** menu.
- Press the **■▲** button repeatedly to highlight the **Factory Reset** menu page.
- Press the **Menu** button and wait a few seconds while the settings are reset.

The menu closes 5 seconds after the last button press, so you need to be fairly quick.

### Fitting the Remote Control handset batteries



Use a small coin to release the screw securing the back plate.

Lift the screw a little and slide the back plate off.

Fit 2 AA size batteries by pressing the flat end (-) against the spring and pressing the battery into the slot, so that the + end makes contact with the stud.

Slide the back plate into place and tighten the screw.



Failure to fit the batteries correctly can damage your Remote Control. Such damage is not covered by the warranty.



Please dispose of used batteries properly at a waste disposal site, not in the household waste.



## STEP 1 – Connecting the Analogue Outputs

Choose one of the following two sections:

### Using a preamplifier

- Set the preamplifier volume control to minimum.
- Connect either the balanced (XLR connectors) or unbalanced (RCA phono connectors) outputs on the Player's rear panel to matching line level inputs on your preamplifier (probably labelled CD or AUX).
- Use the Player's **Volume**↑ button to set the volume to maximum (**0.0dB** on the display).
- Slowly increase the preamplifier volume until the music is at the desired level.

### Using a power amplifier directly

- Use the Player's **Volume**↓ button to set the volume to minimum ( **-60.0dB** on the display).
- Connect either the balanced (XLR connectors) or unbalanced (RCA phono connectors) outputs on the Player's rear panel to matching inputs on your power amplifier. Switch on the power amplifier.
- Press the Player's **Volume**↑ button until the music is at the desired level.

The balanced and unbalanced outputs are separately buffered, you can connect both at the same time if required.

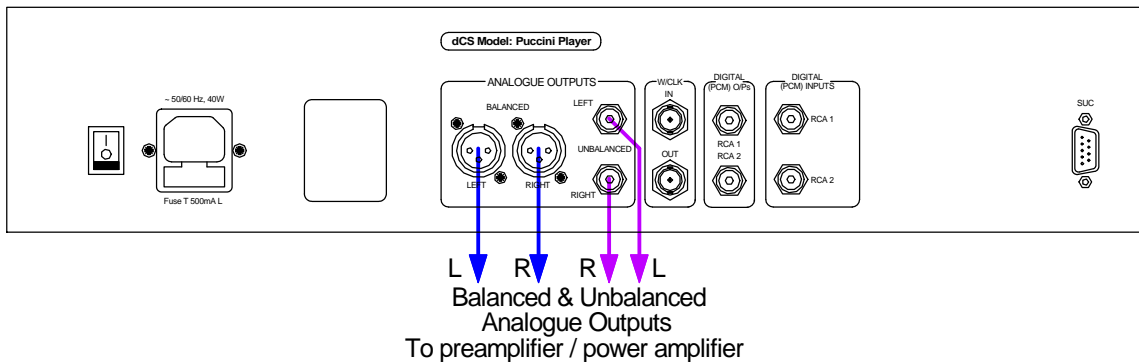



Figure 1 – Basic set-up









## STEP 2 – Playing a Disc

- Press the  button.

The display will show **OPEN**.

- Load a CD or SACD into the tray with the label upwards and press the  button again.

The display will show **CLOSE**, then **LOADING**. The disc type will be identified, either **CD** or **SACD** appears on the display, along with the number of tracks and the total playing time. The Transport will play the SACD layer of a hybrid disc by default, but you can select the CD layer instead using the **CD/SACD** menu page (see the Menu section on page 19 for details).

- Press the  button to start the disc playing. Turn up the Volume to a comfortable level. Enjoy the music! For all discs, the disc type and elapsed time will be displayed.
- Press the  button to pause playing, press again to resume playing.
- Press the  or  button to skip to the next track or the previous track.
- Press the  or  button to jog through the track. To go faster, press the button again (speed 2) and again (speed 3). Press the  button to return to play mode.
- Press the  button to stop the disc. Press it again to open the tray.



## STEP 3 - Setting the Output Level

If the preamplifier volume setting for a comfortable listening level is too high or too low, you may need to change the **Output Level** setting.



Setting the **Output Level** to **6V** can cause some preamplifiers to overload and distort. For this reason, we recommend the **2V** setting if a preamplifier is used.

Similarly, if you are driving a power amplifier directly and the **Player Volume** setting for a comfortable listening level is higher than **-10.0** or lower than **-20.0**, try changing the **Output Level** setting.

- Press the **Menu** button, press the  button twice, then press the **Menu** button again to display the **Set-up** menu. Press the  button repeatedly to highlight the **Analogue Out** menu page. Press the **Menu** button to change the setting and wait for the menu to close. If the menu closes before you have finished, repeat the whole sequence.

If the setting is **2V** and the **Volume** is still set well below **-20.0**, use of passive attenuators is recommended.



The output level relays can flip over in transit, resulting in one or both channels having a lower or higher level than expected. This can be corrected by changing the **Analogue Out** setting from **2V** to **6V** or vice-versa, then changing back to the original setting.

## STEP 4 – Disc Playing Options

The Remote Control gives access to other features, such as track number selection, repeat track or disc and programming a track sequence.

- To select track 5 as an example, either press button **5** and wait a few seconds or press **0** then **5** within the next few seconds (this is quicker). To select track 12, press 1 then 2.
- Press the **Repeat** button repeatedly to cycle through the options:



**Repeat Track** - repeat the track that is currently playing.



**Repeat Disc** - repeat the whole disc.

**Repeat Off** – normal operation.

- With the disc stopped, press the **Program** button to program a track sequence, next select the track numbers you want to play in any order. We suggest entering 2 digits for each track number, as this will allow you to enter the sequence more quickly.

For example, pressing **Program 05 04 06 Play** will play track 5, then track 4, then track 6 and stop. The unit will display **6PGM3**, where 6 is the last track number entered and 3 is the number of tracks in the sequence. Press the **Clear** button to remove the last track from the sequence (track 6), the display will change to **4PGM2**.

- Press **Program** again to cancel program mode, the unit will display **Program Off**. Opening the CD tray also cancels program mode.

## STEP 5 – Using a Master Clock

Clocking the Player from a dedicated Master Clock (such as the *Puccini U-Clock*) can make some startling improvements to the sound quality. It is a good idea to audition a clock before buying. If you do not have a Master Clock, you can miss out this step.

- Set the clock to generate 44.1kHz and connect one of the Clock's Word Clock Outputs to the Player's **W/Clk Input** with a BNC cable.

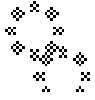

The Sync icon will appear on the display greyed out for a few seconds during locking.



The Sync icon will darken when the Player is locked to the external clock.



This symbol is displayed if activity is detected but the Player cannot lock to the clock signal (for example, because it is at the wrong frequency or level). The Player continues to use its own internal clock.

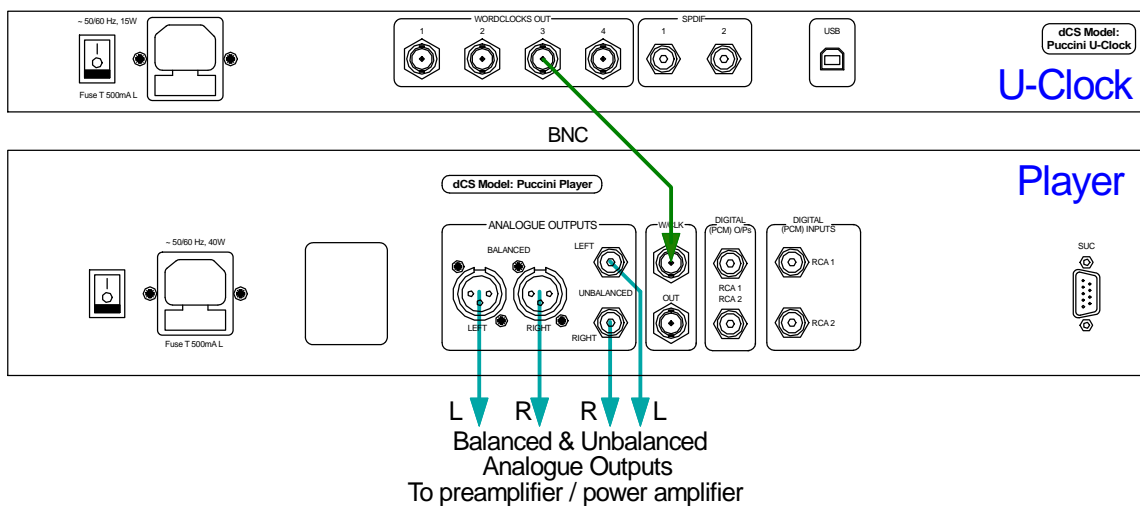



Figure 2 – Using a *Puccini Player* with a *Puccini U-Clock*.

## STEP 6 – Using an External Source

You can use the *Puccini Player*'s internal Ring DAC to convert digital data from an external source to analogue. The unit will lock to 32, 44.1, 48, 88.2, 96, 176.4 or 192kS/s and process word lengths up to 24 bits. If you do not want to use an external source, you can miss out this step.

- Switch on the external source (such as a DAB radio or DVD player) connect its digital output to either the **RCA1 IN** or **RCA2 IN** connector on the *Puccini Player* back panel, using suitable screened digital cables. You can connect both digital inputs if you wish.



- Press the **Input+** button on the remote control to select either the **RCA1**  or **RCA2**  input.

The unit will detect the sample rate of the source, then display the data word length and sample rate (e.g. **16/44.1k**).

- Turn the volume to a comfortable level. You should have audio.
- Enjoy the music!



When using the digital inputs, the CD controls and **W/Clk Output** are disabled.

- To return to disc mode, press the remote control **Input+** button once or twice until the  or  indicators clear and the mechanism re-boots.

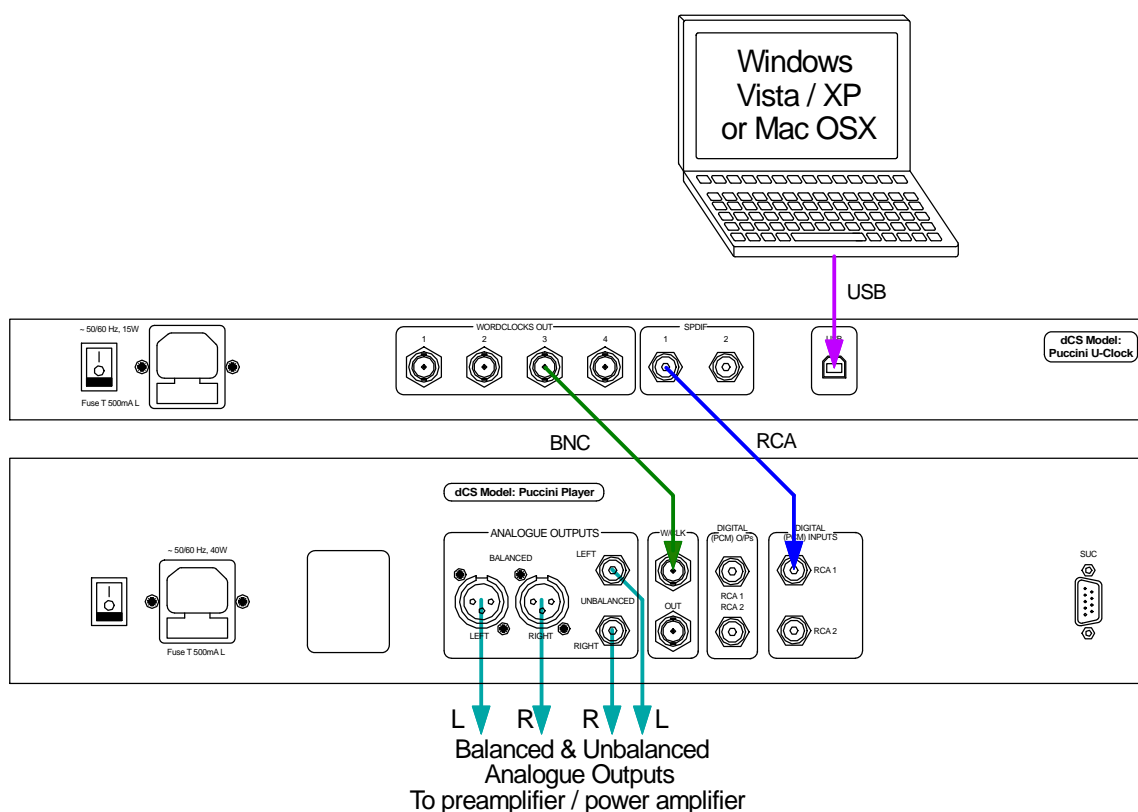

Figure 3 – Using the *Puccini U-Clock* with a *Puccini Player*

*Puccini U-Clock* owners may wish to connect their system to a computer as shown above. For best results, open the menu, set the **Set-up / Clocking / RCA1 Clock Setting** page to **Clock** and (if the Upsampling license has been purchased and loaded) set the **Set-up / Upsampling / RCA1 Upsampling** page to **DSD**. See the *U-Clock* manual for further information.

## STEP 7 – Using the Digital Outputs

Most owners will make use of the *Puccini Player*'s internal Ring DAC to drive the power amplifier directly. If so, you can miss out this step.

When playing CDs, 16bit / 44.1kS/s digital data will appear on the **RCA1** and **RCA2 Digital Output** connectors, which can be used to drive an external DAC.

- Connect one of the RCA digital outputs on the *Puccini Player* rear panel to the matching input of the DAC using suitable screened digital cables.
- Connect the analogue outputs of your DAC to the matching inputs on your preamplifier / power amplifier.
- Connect the power amplifier to your loudspeakers.



*Puccini* is a Player, NOT a Transport, it does NOT down-sample SACD data to PCM. The **Digital Outputs** do not operate when playing an SACD or using the **Digital Inputs**.

Set-up complete!

The next step is crucial – sit back and enjoy the music.

When you have finished listening, you can either keep the player warm by setting it to Sleep mode (press the **Power** button briefly) or switch off (hold down the **Power** button until **Power Down** is displayed, then release).

## FRONT PANEL



Figure 4 – Front panel

### POWER Button

To switch on, ensure the rear panel switch is set to **I** and press the **POWER** button (A) on the front panel once. Note that the unit cannot be turned on from the remote control.

To set the unit to sleep mode, press the **POWER** button once. The main display will turn off, the LED to the left of the button will illuminate, and the outputs will mute, but the unit will remain close to running temperature. Please consider the environment before using this feature! Press again to return to normal operation.

To switch off, hold down the **POWER** button for about 5 seconds until **Power Off** appears on the display, then release it.

When the menu is open, press the **POWER** button to close the menu.

### MENU Button

Press the **MENU** button (B) to open the menu, select menu pages and change settings. See the Menu section on page 19 for information on using the menu features.

### JOG BACK / FORWARD Buttons

◀◀ When a disc is playing, press this button (C) to jog back through the current track. Press again to jog faster (speed 2), press again to jog faster still (speed 3). Pressing this button a fourth time returns to **PLAY** mode. Jogging past the start of track 1 returns to **PLAY** mode.

▶▶ When a disc is playing, press this button (D) to jog forward through the current track. Press again to jog faster (speed 2), press again to jog faster still (speed 3). Pressing this button a fourth time returns to **PLAY** mode. Jogging to the end of the disc stops the disc.

### STOP / EJECT Button

■▲ Press the **STOP / EJECT** button (E) to stop playing a disc. Press again to open the CD tray. Press again to close the CD tray.

When the menu is open, the **STOP / EJECT** button changes to the ← button, used to page backwards through the menu.

When the **RCA1** or **RCA2** inputs are selected as the source, this button acts as the **MUTE** button. The LED to the left illuminates when the player is muted or is not locked to an external source.

### PLAY / PAUSE Button



After a disc has been read, press the **PLAY / PAUSE** button (F) to start playing. Press again to pause and again to resume playing.

When the menu is open, the **PLAY / PAUSE** button changes to the → button, used to page forwards through the menu.

### PREVIOUS TRACK / NEXT TRACK Buttons



Press this button (G) to skip to the previous track, or to the start of the current track if the disc is playing. This feature is easier to use when the disc is stopped or paused.



Press this button (H) to skip to the next track. Skipping past the last track returns to track 1.

### VOLUME ↑/↓ Buttons

Press the **Volume ↑** button (I) to increase the volume or the **Volume ↓** button (J) to reduce the volume.

### Remote Control Receiver

Aim the remote control handset towards the receiver (K) for best sensitivity.

### Display

In normal use, the display (M) is split into 6 areas:

When stopped, the number of tracks on the disc is shown. When playing or paused, the current track number is shown.

Track or disc time (hours, minutes, seconds)

Track elapsed time or Track remaining time or Total elapsed time or Total remaining time icon

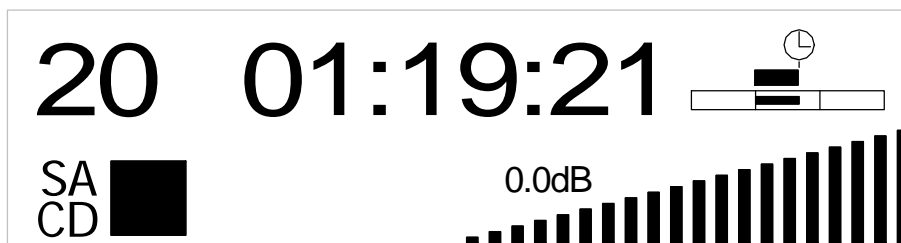

Disc type or hybrid disc layer or input: **SACD, CD, 1** or **2**.

The symbol indicates the mechanism status: Stop, Play, Pause, Fast Reverse, Fast Forward, Open or Close.

The Sync symbol appears when the player is locked to a clock.

**PGM** appears if a track sequence has been set up.

 appears when the **Phase** menu page is set to inverted.

The staircase icon and the level in dB show the Volume or Balance setting.

Details of the menu displays are shown in the Menu section on page **19**.

If the display is turned off in the **Display Settings / Display Off** menu page, the LED (L) above the display illuminates.

### CD Tray

When loading a CD or SACD into the CD tray (N), ensure the disc is central with the label upwards and is seated correctly.



## REAR PANEL



Figure 5 - Rear Panel

### Mains inlet

Power is connected via a standard IEC320 connector (P), protected by a fuse (Q) and isolated by a 2-pole power switch (O). The “Live” or “Phase” pin on the inlet is closest to the switch.

### Analogue Outputs

The unit features separately buffered **Balanced Outputs** (R) on XLR connectors and **Unbalanced Outputs** (S) on RCA connectors. The **Balanced Outputs** should be connected to true balanced inputs only. If your preamplifier / power amplifier has unbalanced inputs (even if the inputs are on XLR connectors), please use the **Unbalanced Outputs** instead.

### Word Clock Input / Output

When playing a disc, the **W/Cik In** connector (T) will accept standard 44.1kHz word clock from a master clock. When the Digital Inputs are in use and are driven by a source that is locked to the Master Clock, the *Puccini's* **W/Cik In** connector may be connected to the Master Clock. Open the menu and set the **Set-Up / Clocking** page to lock the *Puccini* to the Master Clock.

When playing a disc, the **W/Cik Out** connector (U) carries a 44.1kHz word clock. When the Digital Inputs are in use, this output is disabled.

Word clock is used for synchronisation only, it does not carry digital audio data.

### Digital Inputs

The unit features 2 co-ax SPDIF inputs, labelled **RCA1** or **RCA2** (W), selected by the Remote Control **Input +/-** buttons or the **Settings / Source** menu page. These inputs will accept up to 24 bit PCM digital data at 32, 44.1, 48, 88.2, 96, 176.4 or 192ks/s.

### Digital Outputs

The unit features 2 co-ax SPDIF outputs on RCA phono connectors, **RCA1** and **RCA2** (V). These outputs carry CD format PCM data (16 bits at 44.1ks/s) only when playing a CD. They are disabled when playing an SACD or when using the Digital Inputs.

### SUC Connector

The **SUC** connector (Y) is an RS232 interface, primarily used to remotely control the unit during automated testing. The remote control codes for programming a household automation system may be downloaded from [www.dcsLtd.co.uk/page/support](http://www.dcsLtd.co.uk/page/support) . Note that we recommend using infra-red remote control instead.

## REMOTE CONTROL



Hold down the **Sleep** button for 2 seconds to set the system to sleep mode. Press the **Sleep** button again to return to normal operation.

In Sleep mode, press the **OFF** button to turn the Player off.

(The **Upsampler Input** & **Output** buttons are for use with a *dCS* Upsampler.)

The **Filter** buttons changes the filter setting. (In Filter mode, the **Mute** button flips between **DSD Filter** or **DSP Filter**.)

The **Balance** button toggles between Volume and Balance adjustment modes.

The **Input +** and **Input -** buttons cycle through Disc mode and the two Digital Inputs.

(The **AES** and **1394** buttons are for use with a *dCS* DAC.)

The **Vol+** and **Vol-** buttons adjust the Volume / Balance.

**Mute** turns the Analogue Outputs off and on.

The **Program** and **Clear** buttons are used with the **0 – 9** buttons to set or change a track sequence for the loaded disc.

The **0 – 9** buttons select the current track. Pressing **5** or **05** will select track 5.

The **Stop/Eject**, **Play/Pause**, **Previous Track**, **Next Track**, **Jog Back** and **Jog Forward** buttons operate in the same way as those on the Player front panel.

The **Repeat** button cycles through **Repeat Track**, **Repeat Disc** and **Repeat Off**.

The **Display** button changes the time displayed, cycling through the following 4 options and changing the icons on the display:

**Track Elapsed**



**Track Remaining**



**Total Elapsed**



**Total Remaining**



When the Player is completely off (not just in sleep mode), press the front panel **Power** button to turn it on. You cannot use the Remote Control for this. The **OFF** button will only operate if the system is in sleep mode.

# THE MENU

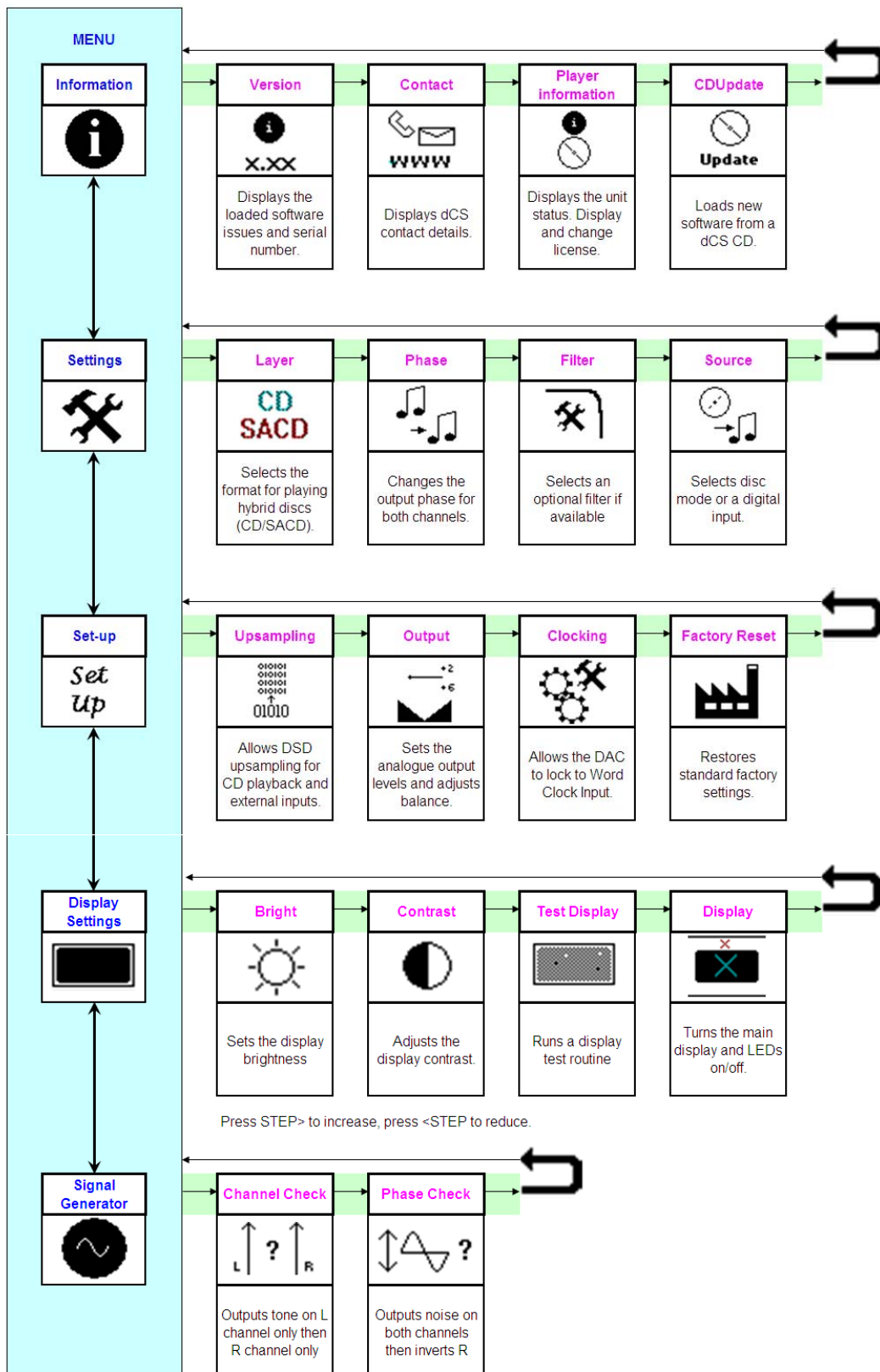

Figure 6 – The menu sequence

## Using the Menu

The menu gives the user access to a range of additional features. It also allows new features and performance enhancements to be added at a later date by software upgrades.

The menu is controlled by four buttons.



Press the **MENU** button to open the menu or select a setting.

Press the **>** button to page forward through the menu.

Press the **<** button to page backward through the menu.

Press the **POWER** button to close the menu or just wait 5 seconds.

Use the Menu Guide sheet to help you find the right menu.

There are five top-level menu pages:



The **INFORMATION** menu gives software issues, serial number, contact details and unit set-up details.



The **SETTINGS** menu allows you to set some features that are not directly accessible from the front panel.

*Set  
Up*

The **SET-UP** menu gives access to settings that are usually changed only when the system is installed.



The **DISPLAY SETTINGS** menu is used to adjust and test the display.



The **SIGNAL GENERATOR** menu is used to check the system during set-up.

Use the **>** button to move the highlight to the menu you want, then press the **MENU** button to select it. The next menu level down is displayed. Use the **>** button to move the highlight to the menu page you want, then press the **MENU** button to display the information or change the setting.



Select the exit icon to go back to the previous menu level.

## INFORMATION Menu

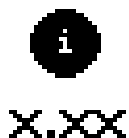

The **Version** page displays the software versions loaded in the unit and the full serial number. Please have this information ready if you contact your dealer for any reason.

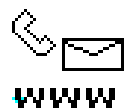

The **Contact** page displays *dCS* web-site URL, email address, telephone and fax numbers. If you have any difficulty, please contact your dealer for help first.

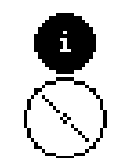

The **Player Information** page displays the unit status:

- DAC Source: Disc (none) / CD / SACD / RCA1 / RCA2
- Wclk In: Inactive / Locked @ ....kHz
- I/F version: x.xx
- B/E version: x.xx
- F/E version: x.xx
- Features: None / Upsampling
- Key: xxxxx-xxxxx-xxxxx-xxxxx-xxxxx

Use the **<** and **>** buttons to scroll up and down the list. Pressing the **MENU** button while at the top of the list returns to the previous menu.

If you have purchased a license from *dCS* to activate a new feature, scroll to the bottom of the **Player Information** screen and press the **MENU** button to display the **License** screen:



Use the number buttons on the remote control to enter a new 25-digit license key and then press the remote's **MUTE** button to accept it. The name of the new feature (e.g. Upsampling) will be added to the Features list. If you make a mistake while entering the code, use the remote's **VOLUME +/-** buttons to scroll back through the key and correct it. Keys are unique to each unit, the Player will reject an incorrect key.



The **CD Update** feature allows you to load new software into your *Puccini Player*. Please follow the instructions supplied with the update CD carefully.

While playing an SACD or using the Digital Inputs, CD Updating is not possible and the icon will be greyed out. Use the front panel controls during an update as the remote control may not operate.

## SETTINGS Menu



The **Layer** page allows you to select either the **CD** or **SACD** layer when playing a hybrid disc. The active layer will be shown as dark, the other layer will be greyed out. While changing layers and re-reading the disc, **Loading...** is displayed.



**Phase** is usually set to **Normal**.



When **Phase** is set to **Inverted**, the  symbol appears on the display and the signals on all of the **Analogue Outputs** are phase inverted. We have found that tracks are occasionally recorded with absolute phase inverted, this feature corrects the error.



The **Filter Settings** menu page opens a lower level with separate pages for the **DSD Filter** and the **DSP Filter**.

**1**

The 4 **DSD Filters** progressively reduce the out-of-band noise level (which is inherent in the 1-bit nature of DSD). **Filter 1** is the usual setting – it gives the widest bandwidth (about 70kHz) and the highest level of out-of-band noise.

**2**

If your system sounds harsh, try **Filter 2** or **Filter 3**. These progressively reduce the out-of-band noise level at the cost of some bandwidth.

**3**

**Filter 4** is primarily intended for troubleshooting, not listening, as it has an early cut-off, designed to minimise the out-of-band noise.

**4**

There are no DSD filters available when **Upsampling** is turned **Off**, so the **DSD Filter** icon is greyed out.



There are 3 **DSP Filter** choices for reconstructing PCM data.

The **Classic Filter** gives good all-around performance.



The **Long Filter** is a symmetrical filter with more taps, offering improved anti-imaging performance.



The **Asym Filter** is an apodising asymmetric filter, featuring a similar frequency response to the Long Filter, but with no pre-ringing.

The best DSP Filter is a personal choice that may depend on the type of music you are playing.

It is easier to change filters using the remote control. First, press the **Filter** button to view the current filter, press it again to change the filter choice or press the **Mute** button to flip between changing the **DSP Filter** setting or the **DSD Filter** setting.



If you don't want to spend time listening to the filter combinations, the most popular filter settings are **DSD Filter 1** and the **Asym Filter**.



Set the **Source** menu page to **Disc** to play CDs or SACDs.



Set the **Source** menu page to **RCA1** or **RCA2** to select data from an external digital source (such as a *Puccini U-Clock* or a DVD player) connected to one of the **Digital Inputs**.



Note that the CD mechanism is turned off while a **Digital Input** is selected.

It is quicker to change source using the **Input+** and **Input-** buttons on the remote control.

## SET-UP Menu

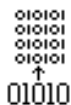

The **Upsampling Options** menu page opens a lower level with three more pages. These allow upsampling to DSD to be turned off or on separately for each source.



Set to PCM (left icon) to oversample CD data directly. Most listeners prefer to upsample to DSD (right icon) before oversampling.



Set to PCM (left icons) to oversample data from the **RCA1** or **RCA2** inputs directly. Select DSD (right icons) to upsample to DSD before oversampling. When upsampling is active, **UPS** is displayed beside the connector icon.



If the upsampling icons for the **RCA1** & **RCA2** inputs are greyed out, this feature is inactive. You can obtain a license to activate this feature by completing the enquiry form on our web-site ([www.dcsLtd.co.uk/page/contactus?p=enquiry](http://www.dcsLtd.co.uk/page/contactus?p=enquiry)). Please remember to state the serial number of your Player and the software issue. We make a charge for licensing units shipped from *dCS* before the price was reviewed on 1<sup>st</sup> April 2009. Please see page **21** for instructions on loading a license.



The **Output Settings** menu page opens a lower level with two more pages:

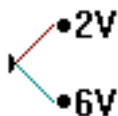

This page sets the **Output Level** to **2V** rms or **6V** rms at full scale. When you set up your system, choose the **Output Level** setting that gives a comfortable listening level with the **Volume** set between **-10dB** and **-20dB**. The difference between the two settings is about 10dB. See page **10** for more details on setting the **Output Level** to suit your system.



In **Balance** mode, use the **<** and **>** buttons to adjust the **Balance**. Each channel can be varied from **0dB** to **-6dB** in 0.1dB steps, then mute (**-∞**) below that. **Balance** adjustment ends after this menu page closes or the **MENU** button is pressed. It is easier to adjust the **Balance** from the listening position using the remote control.





The **Clocking** menu page opens a lower level with two more pages. These allow the DAC to be either slaved to the digital input or locked to a system clock connected to the **W/CLK IN** connector while accepting data from the digital input. Performance is generally improved by the correct use of a high-quality system clock unit.



Slave to **RCA1** digital input (left icon) or lock to system clock while taking data from **RCA1** (right icon).



Slave to **RCA2** digital input (left icon) or lock to system clock while taking data from **RCA2** (right icon).



When playing a disc, the player will always lock to **W/CLK IN** if there is a suitable 44.1kHz Word Clock present.



When using a system clock, you must apply these two rules for correct operation:

The source equipment **MUST** be locked to the system clock. If your source cannot lock to the system clock, set the Player to slave to the digital input.

The data sample rate **MUST** be an exact multiple of the clock frequency. So, if the data rate is 44.1 (as for disc), 88.2 or 176.4kS/s, the clock frequency must be 44.1 or 88.2kHz. If the data rate is 32, 48, 96 or 192kS/s, the clock frequency must be 32, 48 or 96kHz.



The **Factory Reset** menu page resets the unit to standard settings. These are:

**Volume** to **-30dB**.

Hybrid **Layer** to **SACD**.

**DSD Filter** to **1**.

**PCM filter** to **Classic**.

**Phase** to **Normal**.

**Source** to **Disc**.

**CD Upsampling** to **DSD**.

**RCA1 Upsampling** to **PCM**.

**RCA2 Upsampling** to **PCM**.

**Output Level** to **2V**.

**Balance** to centre.

**RCA1 Clocking** to **Audio**.

**RCA2 Clocking** to **Audio**.

**Program** to **Off**.

**Repeat** to **Off**.

**Display** to **On**, **Track Elapsed**.

**Brightness** to maximum.

**Contrast** to 40%.

## DISPLAY SETTINGS Menu

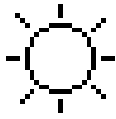

Set the display **Brightness** to a comfortable level using the < and > buttons. The **MUTE** LED dims when this setting is below 50%.



Set the display **Contrast** to a comfortable level using the < and > buttons.



This page runs a **Display Test** routine, which flashes all the indicators and the main display.



The **Display On / Off** menu page controls the display and LED indicators.



Select the page once and the display will turn off after the menu times out. The blue LED over the display illuminates to show the display has been turned off. Operating the controls turns the display back on briefly.



Select the page a second time to turn off the **MUTE** and **DISPLAY OFF** LEDs also after the menu times out. Select the page a third time to turn the display back on.

## SIGNAL GENERATOR Menu

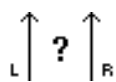

Use the **Channel Check** routine to test the system for swapped channels. A tone is output on the left channel only while the display shows **Left**, then the right channel only while the display shows **Right**. If these are the wrong way around, the left and right channels are swapped somewhere in your system.

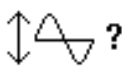

Use the **Phase Check** routine to test the system for phase reversals. Noise is output in phase on both channels while the display shows **In Phase**. Press the **MENU** button, the noise on the right channel is inverted while the display shows **Out of Phase**. The first burst should produce a central image, the second burst should not. If these are the wrong way around, one channel in your system is phase inverted. Press the < or > button to stop the test and return to the menu.

**SPECIFICATION**

Mechanism type	Dual laser CD/SACD mechanism.																		
Converter type	5-bit, 2.822 or 3.07MS/s oversampled, <i>dCS Ring DAC</i> <sup>TM</sup> topology. <u>All</u> data is ultimately oversampled to this format before conversion to analogue.																		
Upsampling	When playing a CD, the data may be upsampled to DSD before oversampling (set in the menu). Upsampling of data from the Digital Inputs to DSD may be activated by loading a license, which may be ordered from <a href="http://www.dcsLtd.co.uk">www.dcsLtd.co.uk</a> .																		
Digital Inputs	2x SPDIF on 2x RCA Phono connectors. Each will accept PCM data at 32, 44.1, 48, 88.2, 96, 176.4 or 192kS/s and process up to 24 bits.																		
Digital outputs	2x SPDIF on 2x RCA Phono connectors. Both output CD format PCM data when playing a CD ONLY.																		
Clocking	Word Clock Output on 1x 75Ω BNC connector. When playing a disc, a TTL-compatible 44.1kHz word clock is available on this output, derived from the internal crystal oscillator or the external system clock. The calibration accuracy when shipped is +/-10ppm, not temperature compensated. Calibration usually remains stable for several years, but this is not guaranteed. This output is disabled when the Digital Inputs are in use.																		
	Word Clock Input on 1x 75Ω BNC connector. The Player can lock to standard word clock at 32, 44.1, 48, 88.2 or 96kHz when the data rate is an exact multiple of the clock frequency. Sensitive to TTL levels, input impedance is 75Ω.																		
Frequency response (Set to DSD Filter 1 / DSP Classic Filter)	<table> <tr> <td>CD</td> <td>+/-0.1dB, 10Hz to 20kHz</td> <td></td> </tr> <tr> <td>SACD</td> <td>+/-0.1dB, 10Hz to 20kHz</td> <td>-3dB @ &gt;66kHz</td> </tr> <tr> <td>Fs = 32kS/s</td> <td>+0.1/-0.5dB, 10Hz to 15kHz</td> <td></td> </tr> <tr> <td>Fs = 44.1 or 48kS/s</td> <td>+/-0.1dB, 10Hz to 20kHz</td> <td></td> </tr> <tr> <td>Fs = 88.2 or 96kS/s</td> <td>+/-0.1dB, 10Hz to 20kHz</td> <td>-3dB @ &gt;38kHz</td> </tr> <tr> <td>Fs = 176.4 or 192kS/s</td> <td>+/-0.1dB, 10Hz to 20kHz</td> <td>-3dB @ &gt;67kHz</td> </tr> </table>	CD	+/-0.1dB, 10Hz to 20kHz		SACD	+/-0.1dB, 10Hz to 20kHz	-3dB @ >66kHz	Fs = 32kS/s	+0.1/-0.5dB, 10Hz to 15kHz		Fs = 44.1 or 48kS/s	+/-0.1dB, 10Hz to 20kHz		Fs = 88.2 or 96kS/s	+/-0.1dB, 10Hz to 20kHz	-3dB @ >38kHz	Fs = 176.4 or 192kS/s	+/-0.1dB, 10Hz to 20kHz	-3dB @ >67kHz
CD	+/-0.1dB, 10Hz to 20kHz																		
SACD	+/-0.1dB, 10Hz to 20kHz	-3dB @ >66kHz																	
Fs = 32kS/s	+0.1/-0.5dB, 10Hz to 15kHz																		
Fs = 44.1 or 48kS/s	+/-0.1dB, 10Hz to 20kHz																		
Fs = 88.2 or 96kS/s	+/-0.1dB, 10Hz to 20kHz	-3dB @ >38kHz																	
Fs = 176.4 or 192kS/s	+/-0.1dB, 10Hz to 20kHz	-3dB @ >67kHz																	
Spurious responses	Better than -100dB0, 20Hz - 20kHz.																		
L-R crosstalk	Better than -80dB0, 20Hz - 20kHz.																		
Output levels	2V r.m.s. or 6V r.m.s. on all outputs for a full-scale input, set in the menu.																		
Balanced outputs	1 stereo pair on 2x 3-pin male XLR connectors (pin 2 = hot, pin 3 = cold), electronically balanced and floating, the signal balance ratio at 1kHz is better than 40dB. Output impedance is 3Ω, maximum load is 600Ω (a 10kΩ load is recommended).																		
Unbalanced outputs	1 stereo pair on 2x RCA Phono connectors. Output impedance is 52Ω, maximum load is 600Ω (a 10kΩ load is recommended).																		
Size and weight	460mm (18.1") W x 400mm (15.8") D x 110mm (4.4") H including feet. Allow extra depth for cable connectors. Allow space for air flow around the unit. Weight 12.1kg (26.6lbs).																		
Power requirements	The unit can be internally set to 100, 115/120, 220 or 230/240V AC, 49 – 62Hz. Power consumption: 30W typical, 40W maximum.																		

These specifications are subject to change without notice.

## MAINTENANCE AND SUPPORT

### Service and Maintenance

dCS audio products contain no user serviceable parts apart from the mains fuse. If your unit is damaged in any way, please contact your dealer.

### Replacing a Blown Mains Fuse

There is a mains fuse below the power inlet, accessible from the outside of the unit. If the fuse blows, it may be changed by the user. The current consumption of the unit is very low, so it only blows if power surges occur, or there is a fault in the unit. Usually power surges cause no other damage, but if the fuse blows repeatedly on replacement, some other damage will have been done and the unit will need to be repaired.

Fuse type: 20mm x 5mm T0.5 amp L fuse



If the fuse should fail, it is essential that it is replaced with one of the same type and rating. Failure to do so could result in damage to the unit, risk of fire or electric shock and will invalidate the warranty.

Referring to the diagram below, remove the power cable, use a small flat bladed screwdriver to pry up the tab on the fuse carrier (A) and pull it out. Push the blown fuse out of the clip in the carrier (B) and dispose of it. Fit a new fuse in the clip (C) and push the carrier back into the unit so that it clicks home. Spare fuses are provided with the unit.

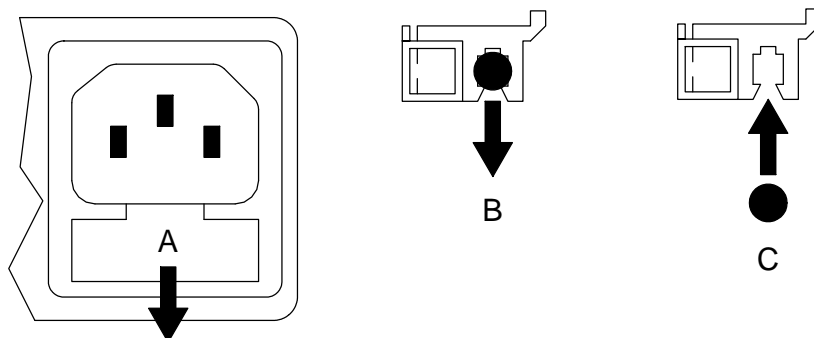

### Cleaning the case

The front panel of your dCS equipment is machined from very high grade aluminium. Great care has been taken to create the finish of the aluminium throughout the engineering process from the raw solid material to the finished piece.

To remove loose dust or finger marks from the case, we recommend that you use a clean, dry, lint-free cloth.

To restore the finish on the front panel, we recommend applying small quantities of a lanolin based cleaner, using a clean, dry, lint-free cloth and then wiping off. Do not allow lanolin to collect around the buttons.

Small amounts of glass cleaner containing ammonia may be used to clean other surfaces, but avoid spraying onto the connector contacts.

## Limited Warranty

### General

dCS warrants this product against defects in materials and workmanship for a period of 3 years from the date the unit was originally shipped from dCS. During the warranty period, dCS will repair or, at our absolute discretion, replace a faulty product. Warranty repairs must only be carried out by dCS or our authorised service agents. Please contact your dealer if your unit requires service.

Your dealer should have completed on your behalf an **Owner Registration** form at the time of sale and returned it to dCS. On receipt of the Owner Registration form, dCS will add your contact details to our customer database. dCS will use this information for warranty and customer support purposes only.

This warranty applies to the original owner.

### Warranty Exclusions

The Warranty does not cover:

- wear and tear, or contamination of the optical system (for example, by tobacco residue).
- shipping charges or tax/duty.
- products re-sold by dCS on a "used" basis – these will be subject to reduced warranty terms.

The Warranty on this product will be void if:

- the product is misused in any way.
- any unauthorised modifications or repairs are carried out.
- the product is not used in accordance with the Operating Conditions stated in this manual.
- the product is serviced or repaired other than by dCS or our authorised service agents.
- the product is operated without a mains earth (or ground) connection.
- the unit is returned inadequately packed.

dCS reserve the right to apply a service charge if a product returned for warranty repair is found to be operating correctly, or if a product is returned before a dCS returns number has been issued.

Our dealers or distributors are NOT authorised to extend the terms of this warranty, dCS cannot accept responsibility for any attempt to do so.

### Obtaining Service

Should you encounter a problem, contact your authorised dCS dealer for advice, quoting the model, the full serial number, software version number, and giving a detailed description of the fault. Your dealer will advise you fully on actions that need to be taken. When returning a unit, the original packaging should be used to avoid transit damage. Replacement packaging sets may be purchased from dCS.

During the Warranty period, there will normally be no charge for parts or labour.

### Operating Conditions

- The supply voltage must remain within +/-10% of the A.C. voltage specified on the back panel.
- The supply frequency must be in the range 49Hz to 62Hz.
- Ambient temperature range: 0°C (32°F) to 40°C (104°F), non-condensing.
- Do not install the unit near heat sources such as radiators, air ducts, power amplifiers or direct strong sunlight.
- If in doubt, the easy test is – the unit is happy to work anywhere a human is.

## If you need more help

In the first instance, you should contact your dealer. If they cannot resolve the issue, contact your national distributor.

Manufactured by:

Data Conversion Systems Ltd.  
Unit 1, Buckingham Business Park,  
Anderson Road,  
Swavesey,  
Cambridge. CB24 4AE  
UK

[www.dcsLtd.co.uk](http://www.dcsLtd.co.uk)

This user manual may be downloaded free of charge from our web-site.

A bound copy of this manual may be ordered from *dCS*.

## Software History

*dCS* products make extensive use of software configurable chips – FPGAs and DSPs. This gives us the ability to update our products to add extra features, update digital interface standards or make performance improvements by loading new software. Occasionally, a hardware upgrade may be necessary also to increase the “capacity” of the electronics, add extra connectors or extra front panel controls.

Please note that not all software updates make an earth-shattering change. You should have a clear idea of what you expect to gain before updating to the latest issue. We recommend that you keep your software up to date. Check the *dCS* web-site for the latest software updates.

This manual is for *Puccini Player* software version 1.3x.

- Issue 1.00 – The first issue.
- Issue 1.01 – Bug fixes improve reliability.
- Issue 1.12 – Licensed upsampling for Digital Inputs added – please visit [www.dcsLtd.co.uk](http://www.dcsLtd.co.uk) (or contact *dCS*) to obtain a license.
  - The unit may be locked to a system clock while the Digital Inputs are selected.
  - Display Off can turn off LEDs.
  - The MUTE LED dims when display brightness is set below 50%.
  - Various minor bug fixes.
- Issue 1.20 - 3 PCM filter options added: Classic, Long and Asymmetric.
  - DSD performance improved.
  - Occasional Display Off time-out problems corrected.
- Issue 1.21 - Occasional display problems fixed.
  - Occasional pop when changing sample rate fixed.
- Issue 1.30 - Adds 176.4 & 192kS/s capability to the digital inputs to support *Puccini U-Clock v2*.