

dCS Delius
Stereo Digital to Analogue Converter

User Manual
Software Release 2.3x
September 2004

© *dCS* Ltd. 1999 - 2004

Price UK £17.50 / Euro 25.00

All rights reserved. No part of this publication may be reproduced, stored in or introduced into a retrieval system, or transmitted in any form, or by any means (electronic, mechanical, photocopying, recording or otherwise) without the prior written permission of *dCS*¹. Any person who does any unauthorised act in relation to this publication may be liable to criminal prosecution and civil claims for damages.

Information contained in this manual is subject to change without notice, and whilst it is checked for accuracy, no liabilities can be accepted for errors.

¹ *dCS* is Data Conversion Systems Ltd. Company registered in England No. 2072115.

PRODUCT OVERVIEW

The *dCS Delius* is derived from our award winning *dCS Elgar Plus*, the world's first 24/192-DSD audiophile D/A converter. *Delius* has been designed to closely approach the ultimate performance level of *Elgar Plus*, consistent with a lower parts cost.

All *dCS* DACs feature our patented *dCS Ring DAC* technology. This unveils the intricate low level musical detail that is *dCS*' hallmark.

Delius will accept digital data at 44.1kS/s from your CD player and interpolate the 16 bits, giving your CD collection a new lease of life. *Delius* will also convert 24 bit 96kS/s data from DVD players, revealing the increased depth and spaciousness inherent in the more complex source information. With the current software version, *Delius* also has the ability to act as a master clock for your transport, increasing the clocking precision of the overall system.

Units fitted with the IEEE 1394 interface option can convert DSD data (a single bit data stream, sampled at 2.822MS/s) from a suitably equipped Upsampler or SACD player to extra wide-band audio, taking advantage of the extended bandwidth inherent in the DSD format.

All *dCS* DACs use the same digital processing engine running the same DSP code. The extensive use of programmable logic makes *dCS* products extremely flexible and easy to upgrade. You can load updated *Delius* software from a *dCS* CD using a CD player, or *dCS* service agents can download software to the SUC port, using a PC.

FREDERICK DELIUS (1862 –1934)

The *dCS Delius* is named after Frederick Delius, the English composer. Fritz Theodor Albert Delius was born of German parents in Bradford, Yorkshire on January 29th, 1862. He changed his name to the more English-sounding "Frederick" in 1902.

His father, a wool merchant, encouraged him to play the piano and violin, although he had other plans for his son's career. After college, Fritz represented his father's business for three years, travelling through Sweden, Norway, France and Germany. This lifestyle gave Delius an enduring cosmopolitan and romantic outlook that is reflected in his musical style.

His consuming interest in music developed, to the detriment of his responsibilities to his father's wool business. In frustration, his father sent him to manage his orange plantation near Jacksonville, Florida, USA . Young Fritz was deeply affected by the singing of the local slaves and the beauty of the unspoilt Florida scenery. This environment was the inspiration for his **Florida Suite**. He bought a piano and concentrated on his music, at the expense of the orange-growing business.

In 1885 at the age of 23, Fritz spent a year teaching music in Danville, Virginia. The following year, he finally persuaded his father to finance his musical studies at Leipzig Conservatory, where he met and became fast friends with Edvard Grieg, the Norwegian composer.

He moved to Paris in 1888, where he found himself among kindred spirits such as Ravel and Gauguin. His love of the city inspired him to write **Paris: The Song of a Great City**.

In 1897, he and German artist Jelka Rosen settled in the quiet village of Grez-sur-Loing, near the forest of Fontainebleau, in France. They married seven years later. Delius' music was brought to the British public by the conductor Sir Thomas Beecham.

The major influences on Delius' work were the everglades of Florida, the cool green forests of northern Europe and the snowy fjords of Norway, a passion he shared with Grieg. He loved the tranquillity of the countryside, normally avoiding the bustling cities, except for his extended sojourn in Paris. His love of nature is epitomised in pieces such as **On Hearing the First Cuckoo in Spring**, **Brigg Fair: an English Rhapsody**, **Over the Hills and Far Away**, **In a Summer Garden**, **Summer Night on the River**, **Sea Drift** and **A Song Before Sunrise**. His stage works include **Koanga**, a love story strongly influenced by Afro-American song and dance.

During the First World War, Frederick and Jelka were forced to retreat from their idyllic Grez to take refuge in England and Norway. After the war, they returned to Grez, and his work continued apace.

In 1922, Delius displayed the first symptoms of infection with syphilis. This marked the beginning of a slow physical degeneration, leading to blindness and paralysis in his later years. His mind was undimmed by his illness, and he continued composing. Six years later, he was reduced to dictating to his assistant, composer Eric Fenby. His work during this difficult period is widely considered to be some of his best.

His illness also took its toll on Jelka, the strain of caring for him ruined her health. Frederick Delius died on June 10th 1934 in Grez, attended by his devoted Jelka. He was buried in Limpsfield, Surrey, England.

Recommended recordings

Delius – Orchestral Works

Florida Suite / Over the Hills and Far Away
English Northern Philharmonia
Naxos 553535

Delius: Paris / Brigg Fair / Eventyr / Irmelin / La Calinda

New Zealand Symphony Orchestra conducted by Myer Fredman
Naxos 553001

Delius: Brigg Fair / Dance Rhapsody No.2 / Two Pieces

Conducted by Sir Thomas Beecham
Angel Classics 67553

Beecham Conducts Delius

Conducted by Sir Thomas Beecham
EMI CDS 7 47509 2

Delius – Orchestral Works

EMI Classics ZDMB 5 65119 2

CONTENTS

Product Overview	3
Frederick Delius (1862 –1934)	4
Recommended recordings	5
Contents	6
About this Manual	9
What does the coloured text mean?	9
About Sample Rates	9
Step-by-Step Guide	10
Preliminaries	10
Step 1 – Selecting a Digital Input	11
Connecting to a Single AES or SPDIF source	11
Connecting to a Dual AES Source	11
Connecting to an IEEE 1394 DSD Source	11
Step 2 – Connecting the Analogue Outputs	12
Using a preamplifier	12
Using a power amplifier directly	12
Step 3 - Setting the Output Level	13
Step 4 - Using <i>Delius</i> in Master Mode	14
Other Settings	15
Typical Applications.....	16
Using a 1394-Equipped <i>Delius</i> in Master Mode with <i>Verdi</i>	16
Using a 1394-Equipped <i>Delius</i> and <i>Purcell</i> with <i>Verdi</i>	17
Using a Standard <i>Delius</i> and <i>Purcell</i> with a CD Player	18
The Software – The Menu	20
Using the Function Menu	21
Opening the Menu	21
Types of Menu Page	21
Closing the Menu	21
Menu Sequence	22
Filter – Anti-Imaging Filter Setting	22
Selecting a Filter	22
MS – Master/Slave Operation	23
Setting to Master Mode	23
Mute - Mute Fade Time	24
Fade – Fade Behaviour After Re-Lock	24
Dual AES – Dual AES Mode	25
Swap - Swap Channels	26
Disp - Default Display	26
Out - Output Level	26
Bright x - Display Brightness	27
Phase – Overall Phase	27
De-Emph - De-Emphasis Behaviour	27
Balance - Channel Balance Using Rotary Knob	28
Bal Mode - Balance Information Display	28
Global – Global/Local Volume	28
TimeOut – Menu Time Out Setting	29
PLL - PLL Tracking bandwidth	29
NAud - Non Audio Muting	29
Override Non-Audio Muting	29
Disabling Non-Audio Muting	30
Restoring Non-Audio Muting	30
Ch.Check - Channel Check Test	30
Ph.Check - Phase Check Test	30

Burn In - Burn-In Signal Generation	31
Test - Display Test	32
Issue – Software Issue State	32
Temp – Unit Internal Temperature	32
Serial – Unit Serial Number	32
Contact - Contact information	32
CDUpdate – Software Update By CD	33
Factory – Restoring Factory Defaults	35
Rst Sync – Setting all Inputs to Slave Mode	35
The Hardware – Controls and Connectors	36
Front Panel	36
Key to Front Panel	36
Power Button	36
Input Button	(Step Back) 36
Mute Button	(Step) 37
Status Indicator	37
Remote Control Sensor	37
Main Display	38
Input Indicator	38
Function Button	(Select) 38
Rotary Control	38
Rear Panel	39
Key to Rear Panel	39
Balanced Analogue Outputs	39
Unbalanced Analogue Outputs	40
AES/EBU Digital Inputs	40
SPDIF Digital Inputs	40
Toslink and ST Optical Inputs	40
REC Digital Output	41
1394 Interface	41
Wordclock Digital Input / Output	41
SUC	41
IEC Power Inlet	42
Mains Fuse	42
Additional Information	42
Remote Control	43
Standby Button	43
Function Button	43
Input Selector Buttons	44
Vol/Bal Button	44
Mute Button	44
Purcell Button and LED	44
Phase Button	44
Filter Button	44
Display button	44
Up and Down (↑ / ↓) buttons	44
Delius Technical Information.....	46
Converter Type	46
Digital Interface Specifications	46
Sample Rates	47
Frequency Response (set to Filter 1)	47
Volume Control	48
Balance Control	48
De-Emphasis	48
Analogue Outputs	48
Clocking	48
Synchronising to source	48
Power requirements	49
Size and Weight	49
Operating Conditions	49

General Technical Information.....	50
IEEE 1394 Overview	50
Synchronising IEEE 1394 interfaces	50
Automatic Input Selection	50
<i>dCS</i> IR Remote Control Codes	52
Upsampler	52
DACs	53
Transports	54
Using your <i>dCS Delius</i> for the first time.....	56
What's in the Box?	56
Safety Notice	56
Mains Voltage Setting	57
Positioning the Unit	57
Options	58
IEEE 1394 Interface	58
Mains Supply Voltage	58
Having Your Options Changed	58
Maintenance and Support.....	60
Service & Maintenance	60
Obtaining Service	60
Mains Fuse	60
Replacing a Blown Fuse	60
Fitting or Replacing the Batteries in the Remote Control	61
Opening the battery compartment and removing batteries	61
Fitting new batteries and closing the case	61
Updating your <i>Delius</i>	62
Software Updates	62
Hardware Updates	62
Safety and Electrical Safety	63
Cleaning the Case	63
Troubleshooting	64
Fault Indication	64
Power interruption	64
Power up test errors	64
Non-Audio disk	64
The unit is overheating	64
Troubleshooting Guide	65
The unit fails to power up	65
The unit fails to lock to a digital audio source or displays "No Input"	65
The unit locks but the audio output is low or absent	65
The output is monophonic	65
The unit fails to respond to the controls	66
The Main Display turns on briefly when a control is operated, then turns off	66
The Left and Right channels are swapped	66
One audio output channel is low or absent	66
The sound has a peculiar tonal balance	66
Crackles or pops occur while playing music	67
Erratic operation when locked to 96 or 88.2kS/s on Toslink or ST inputs	67
The unit will not decode Dual AES	67
The unit drops out of Dual AES mode into AES1 or AES2	67
A digital recorder fails to record from the REC Output	67
The Remote Control fails to control the unit	68
While playing a DVD, a burst of noise is heard, <i>Delius</i> mutes and changes sample rate	68
CD Update is interrupted or fails	68
CD Update is interrupted and fails to recover	68
Troubleshooting the IEEE 1394 Interface	69
Upsampler or Transport displays "Inactive"	69
The Unit keeps displaying "No Comms"	69
The Unit keeps displaying "Search.."	69
The DAC displays "Verdi Wordclock Missing"	69
The DAC displays "Missing Wordclock between Clk Out & Verdi Clk In"	69

The DAC displays “Please check source slaved to DAC Wordclock Out”	69
The DAC displays “Wrong Wordclock @ Verdi Clk In”	69
The DAC remains muted	70
The DAC takes a long time to unmute	70
If You Need More Help	71
Other Information	71
Indexes and Software Version Numbers.....	72
Software History	72
Definitions and Abbreviations	73
Key to Cable Identification	74
List of Tables	75
List of Figures	75
Keywords and Phrases	76

About this Manual

If you have not used a *Delius* before, please read the section “Using your *dCS Delius* for the first time” on page **56**.

This manual has been arranged with the most commonly used sections placed first:

- table of contents (page **6**)
- step-by-step (page **10**) and applications guides (page **16**)
- detailed software and hardware information (page **20**)
- technical information (page **46**)
- information for first time users (page **56**)
- options, maintenance and troubleshooting (page **58**)
- index section (page **72**)

What does the coloured text mean?

If you are reading a colour print or a soft copy of this manual, you will notice that some types of text are in colour:

- **Brown text in bold** is a reference to another section or page. Sometimes, if you are reading a soft copy of the manual, page numbers are hyperlinks – click on them and you will go there.
- **Blue text** is used for controls and connectors, described in the hardware section.
- **White text in bold on black** is used for alternative control functions, such as menu operation.
- **Pink text** is a menu page or setting.
- **Green text in bold** shows what appears on the display.
- **Purple text in bold** is used for indicators.

IMPORTANT!

Important information is presented like this - ignoring this may cause you to damage the unit, or invalidate the warranty.

The manual is designed to be helpful. If there are points you feel we could cover better, or that we have missed out - please tell us.

About Sample Rates

All references to sample rates in this manual use the unit kS/s (kilo Samples per second) rather than the technically incorrect kHz.

STEP-BY-STEP GUIDE

This section guides you through setting up the unit for basic operation. You may find this useful if you have not used the *Delius* for a while.

Preliminaries

The **Control Summary** sheet details the menu structure and outlines the use of the front panel controls. For more information, see the Menu section on page **20**.

For digital interfaces, use with cables designed for digital audio:

- for AES/EBU interfaces use 110Ω screened, twisted pair cables fitted with one male XLR connector and one female XLR connector.
- for SDIF, Wordclock or SPDIF BNC interfaces, use 75Ω coax cables fitted with BNC plugs.
- for SPDIF RCA interfaces, use 75Ω coax cables fitted with RCA Phono plugs.
- for TOSLINK optical interfaces, use Toslink fibre-optic cables.
- for IEEE 1394 interfaces, use the IEEE 1394 cable provided with the unit.

For analogue inputs / outputs, use with screened cables of the correct type:

- for balanced inputs / outputs, use screened, twisted pair cables fitted with one male XLR connector and one female XLR connector.
- for unbalanced inputs / outputs, use coax cables fitted with RCA Phono plugs.

do this: Connect the power cable supplied to the Power inlet on the *Delius* rear panel, plug the other end into a convenient power outlet.

IMPORTANT!

Please do not use an excessively thick power cable as this may damage the power inlet connector.

do this: Press the **Power** button and wait about 30 seconds while *Delius* configures itself.

The display will show in sequence: **Delius, Testing ...** and **No Input**.

If the unit is likely to be set in an unfamiliar state, you can reset it as follows:

do this: Press the **Function** button once, then press the **Input** button repeatedly until the display shows **Factory**. Press the **Select** button and wait while the unit reboots.

The **PWR, MUTE** and one of the input indicators will be lit.

Step 1 – Selecting a Digital Input

Switch on the source equipment. If appropriate, load a disk / tape and set the machine in PLAY mode to ensure it is generating a digital audio data stream.

Choose one of the following three sections:

Connecting to a Single AES or SPDIF source

Most source equipment (such as CD transports, DVD players) is fitted with a single wire digital output, usually on an RCA phono connector.

do this: Connect your source equipment to the matching input on the *Delius* rear panel using a suitable cable.

do this: Press the **Input** button repeatedly until your chosen input is displayed on the input indicator, to the right of the display. This will be either **AES 1**, **AES 2**, **RCA1**, **RCA2**, **TOS**, or **BNC**.

The unit will lock to the source, displaying in sequence **Locking**, **d xxx** (the sample rate) then the default display (probably **16/44**, depending on the **Disp** menu setting and the source format).

Connecting to a Dual AES Source

do this: Check that your source equipment is capable of Dual AES operation.

do this: Connect the AES 1 (or AES A) output on your source equipment to the **AES 1** input on the *Delius* rear panel and the AES 2 (or AES B) output to the **AES 2** input, using two XLR cables. Ensure the cables are not swapped.

do this: Press the **Input** button repeatedly until both **AES 1** and **AES 2** input indicators are lit.

The unit will lock to the source, displaying in sequence **Locking**, **d xxx** (the BASE sample rate) then the default display (probably **24/192** depending on the **Disp** menu setting and the source format).

Connecting to an IEEE 1394 DSD Source

(This section applies to units fitted with the IEEE 1394 interface option.)

do this: Check that your source equipment (probably an SACD player or a *dCS* Upsampler) is capable of DSD operation over a 1394 link, generates a 44.1kHz wordclock and is set up correctly.

do this: Connect one 1394 output on your source equipment to one **1394** input on the *Delius* rear panel. Also connect the wordclock output on your source equipment to the **Wordclock In** connector on the *Delius* rear panel.

do this: Press the **Input** button repeatedly until the **1394** input indicator is lit.

The unit may display **Wait ...**, **No-WCik** or **Search..** messages before finally settling down to the source name (probably **Purcell** or **Verdi**). If necessary, use the **Input** button to select the 1394 source you want to listen to. You may find *Delius* settles more quickly if you set it to **1394** mode before setting the source to DSD mode (or switching the source on).

do this: **Proceed to Step 2.**

Step 2 – Connecting the Analogue Outputs

Choose one of the following two sections:

Using a preamplifier

- do this: Set the preamplifier volume control to minimum.
- do this: Connect either the balanced (XLR connectors) or unbalanced (RCA phono connectors) outputs on *Delius* rear panel to matching line level inputs on your preamplifier (probably labelled CD or AUX).
- do this: Turn *Delius* rotary control clockwise to set the **Volume** to maximum (**Vol 0.0** on the display).
- do this: Slowly increase the preamplifier volume until the music is at the right level.

Using a power amplifier directly

- do this: Turn *Delius* rotary control counter-clockwise to set the **Volume** to minimum (**Vol -60.0** on the display).
- do this: Connect either the balanced (XLR connectors) or unbalanced (RCA phono connectors) outputs on *Delius* rear panel to matching inputs on your power amplifier. Switch on the power amplifier.
- do this: Turn *Delius* rotary control slowly clockwise until the music is at the right level.

A basic setup with a CD player is shown in **Figure 1**.

- do this: Proceed to Step 3.

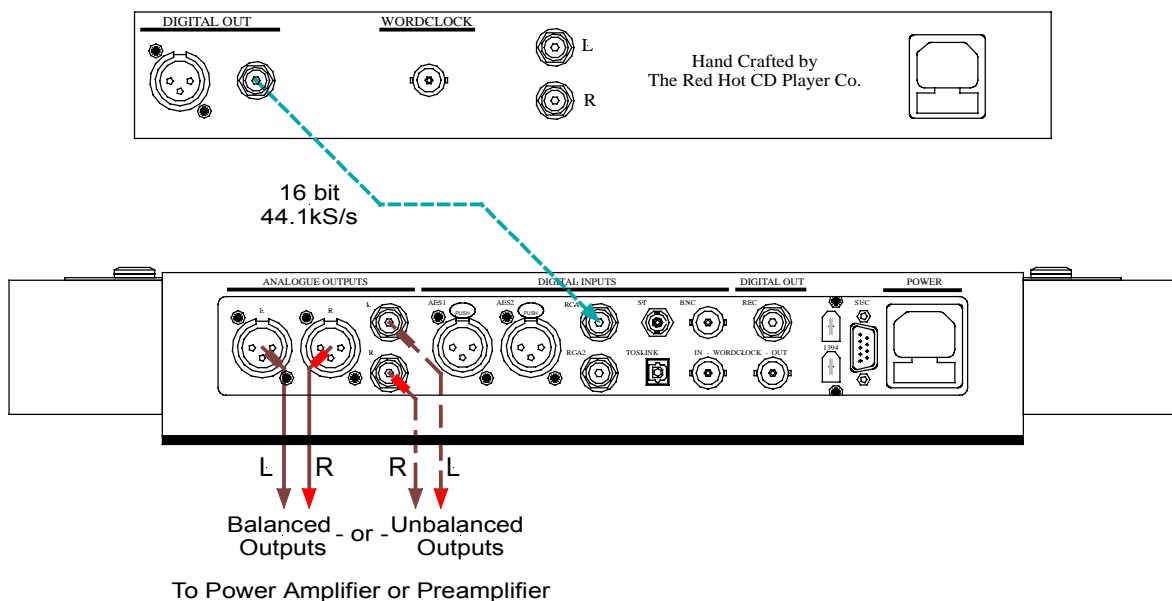

Figure 1 – Basic setup with a CD player

Step 3 - Setting the Output Level

If the preamplifier volume setting for a comfortable listening level is too high or too low, you may need to change the **Output Level** setting. Similarly, if you are driving a power amplifier directly and **Delius Volume** setting for a comfortable listening level is higher than **-10.0** or lower than **-20.0** try changing the **Output Level** setting.

IMPORTANT!

*Do not play music at a high level while changing the **Output Level** setting.*

do this: Press the **Function** button once, then press the **Mute** button repeatedly until the display shows **Out:2V** or **Out:6V**. If the Volume setting is too high, press the **Select** button to change to **Out:2V**. If the Volume setting is too low, press the **Select** button to change to **Out:6V**.

Step 4 - Using *Delius* in Master Mode

If your CD transport (or other source equipment sampling at 44.1kS/s) has a Wordclock input, you can reduce the jitter in your system by using *Delius* in Master mode and slaving the source to it. If not, you can miss out this step.

IMPORTANT!

You can only use Master Mode if your source sample rate is 44.1kS/s.

- do this:** Connect *Delius* **Wordclock Out** connector to the wordclock input on the source equipment. You may need to set the source equipment to slave to wordclock.
- do this:** Press the **Function** button to open the menu, then repeatedly press the **Mute** button until the display shows **MS:Slav**. Press the **Select** button repeatedly until the display changes to **MS:Mastr**.
- do this:** Allow the menu to time-out.

IMPORTANT!

*If you are using an Upsampler, this MUST be set to convert a 44.1kS/s source to either 44.1kS/s, 88.2kS/s, 176.4kS/s or DSD. If not, **Delius** will be unable to lock.*

The equipment will take several seconds to re-lock and settle down, then *Delius* will unmute.

A Master mode setup using a CD player is shown in **Figure 2**.

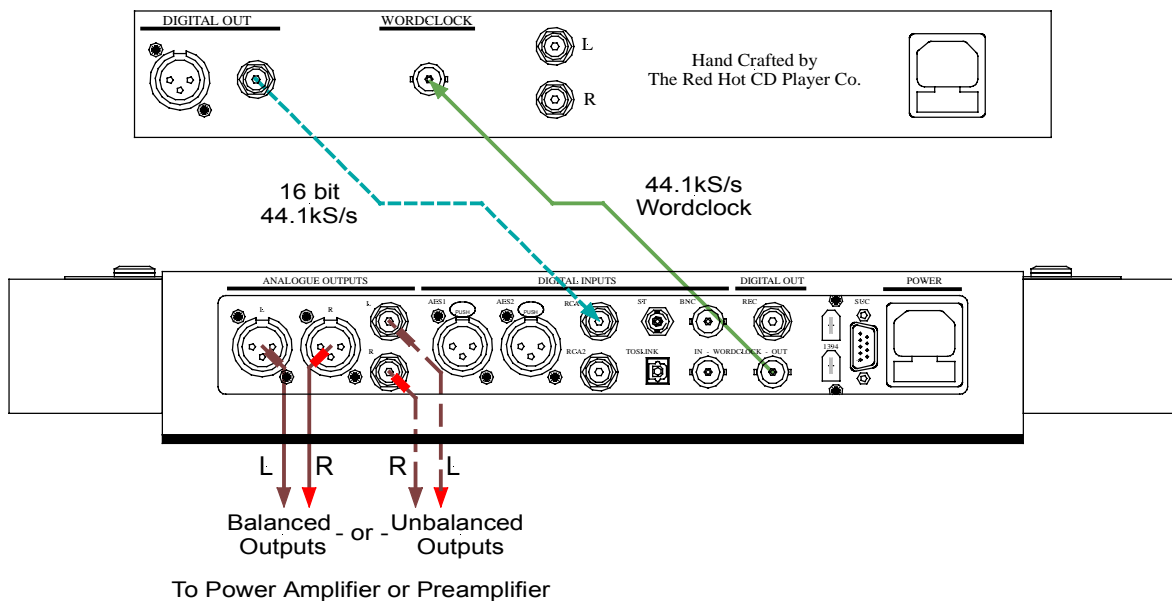

Figure 2 – Using Master Mode with a CD player

Other Settings

The basic set-up procedure is complete.

Many more features are available through the Menu. See the Menu section starting on page **20** for more information.

TYPICAL APPLICATIONS

Using a 1394-Equipped *Delius* in Master Mode with *Verdi*

This setup allows you to play SACDs through the **1394** interface and CDs through the **AES1** interface, with *Delius* in Master Mode.

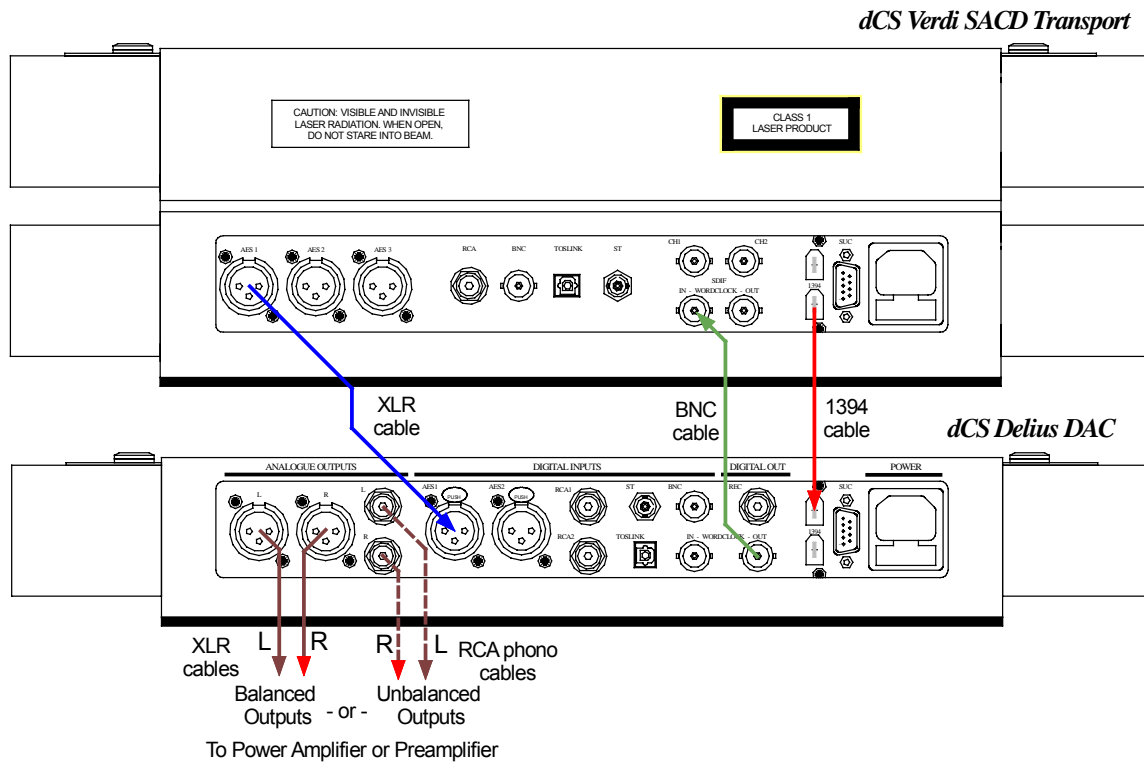

Figure 3 – Using *Delius* in Master Mode with *Verdi*

Connect up as shown above.

- do this:** Open *Delius*' menu and run the **Factory** routine. Use the **Input** button to select the **AES 1** input. Set the **MS** page to **MS:Mastr** and wait for the unit to settle.
 - do this:** Use the **Input** button to select the **1394** input wait for the unit to settle. Set the **MS** menu page to **MS:Mastr** and wait for the unit to settle again.
 - do this:** Use the **Input** button to select the **AES1** input for playing CDs or the **1394** interface for playing SACDs.
- Verdi* v1.2x with *Delius* v2.2x will automatically select the right input.
- do this:** Use the **Volume** control to set a comfortable listening level. Open the menu again and choose a different **Filter** if you wish.

Using a 1394-Equipped *Delius* and *Purcell* with *Verdi*

This setup allows you to play SACDs and CDs through the **1394** interface, upsampling the CDs to DSD with a *Purcell*. *Delius* is in Master Mode.

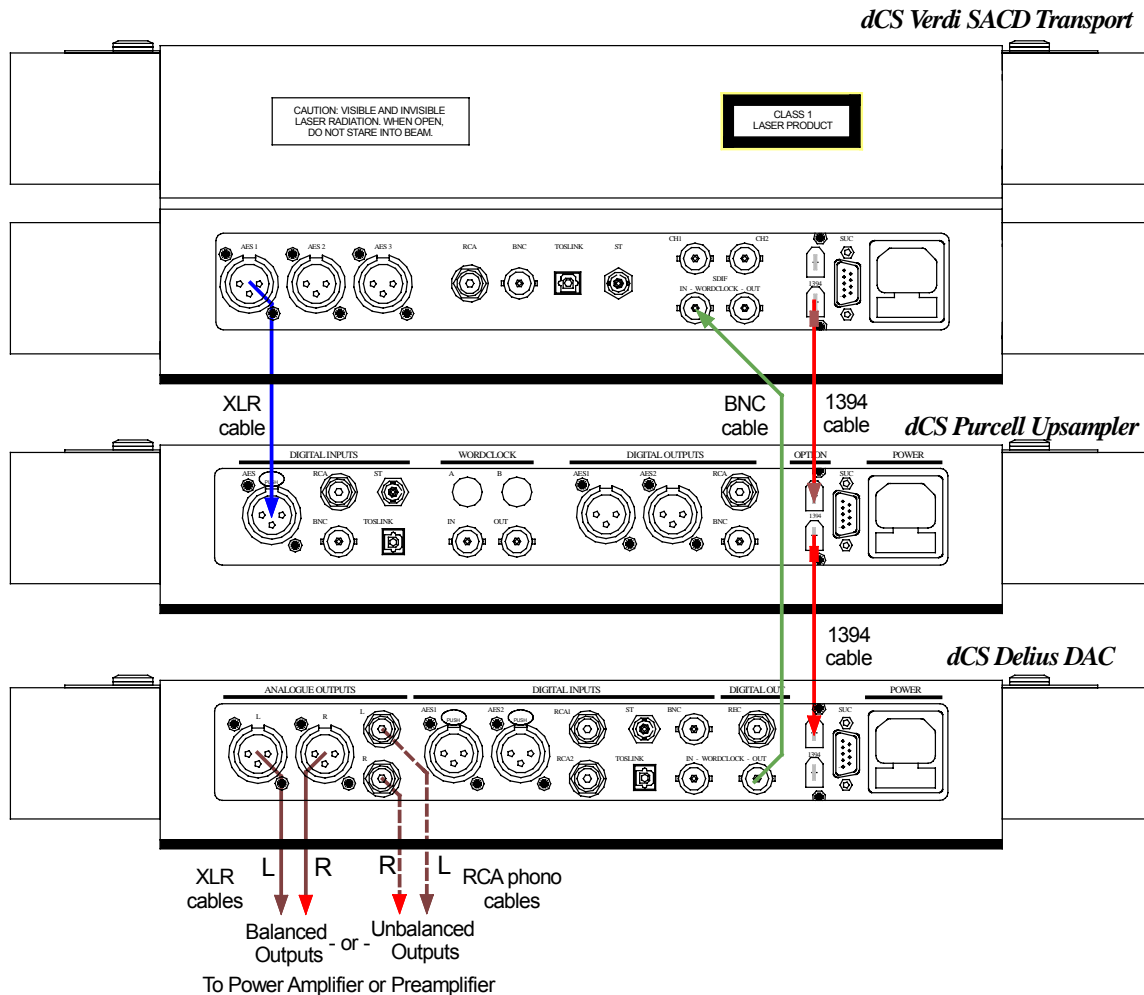

Figure 4 - Using *Delius* in Master Mode with *Verdi* and *Purcell*

do this: Connect up as shown above.

do this: Open *Delius*' and *Purcell*'s menu and run the **Factory** routines.

Purcell set-up:

do this: Use the **Input** button to select the **AES 1** input. Use the **Output** button to select **44.1→DSD**.

Delius set-up:

do this: Use the **Input** button to select the **1394** input wait for the unit to settle. Set the **MS** menu page to **MS:Mastr** and wait for the unit to settle again. Use the **Input** button to select either the SACD feed (**Verdi**) or the upsampled CD feed (**Purcell**).

Verdi v1.2x with *Delius* v2.2x will automatically select the active input.

do this: Use the **Volume** control to set a comfortable listening level. Open the menu again and choose a different **Filter** if you wish.

Using a Standard *Delius* and *Purcell* with a CD Player

If your *Delius* and *Purcell* are not 1394-equipped, you can still upsample the output from a standard CD player to 24 bit 192kS/s.

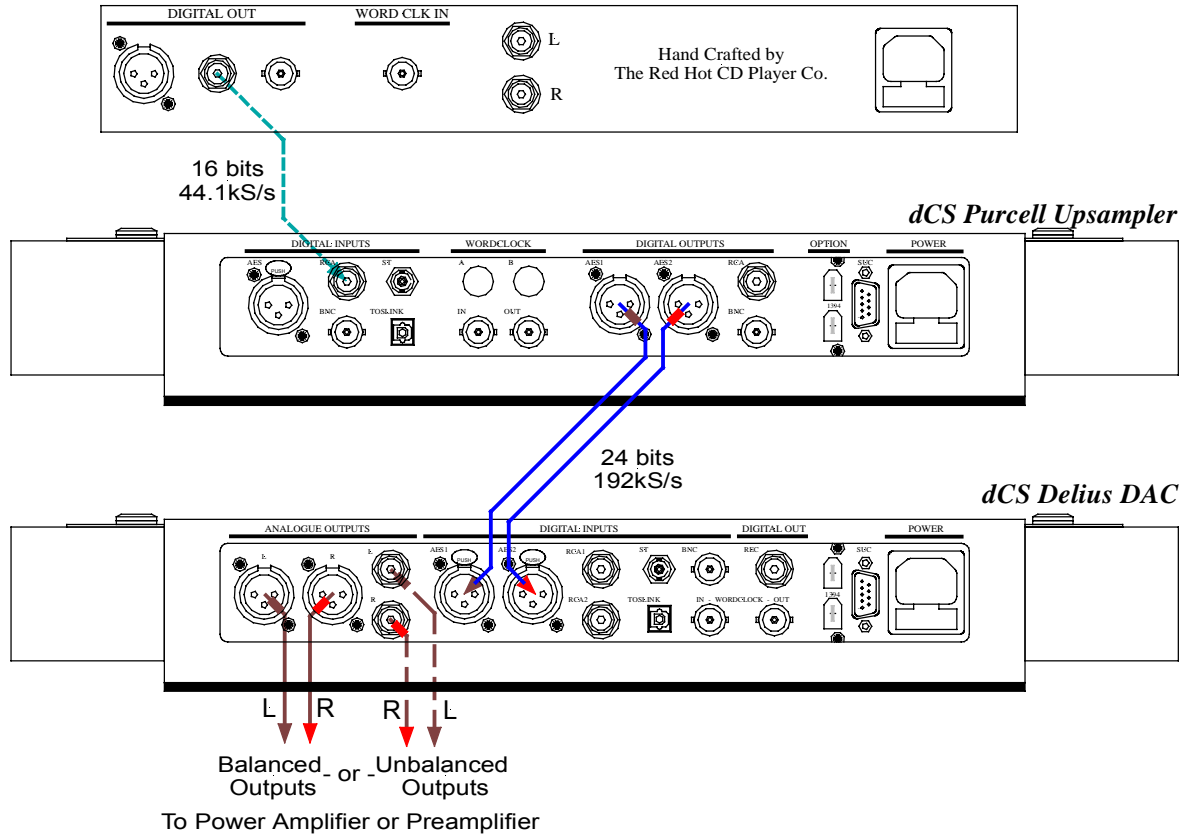

Figure 5 – Using *Delius* with *Purcell* and a CD player

do this: Connect up as shown above.

***Purcell* setup:**

do this: Open the menu and run the **Factory** routine. You can connect any of *Purcell*'s digital inputs to the CD player - use *Purcell*'s **Input** button to select it. Use the **Output** button to set the **44.1→192** conversion.

***Delius* setup:**

do this: Open the menu, run the **Factory** and **RstSync** routines. Use the **Input** button to select **AES 1** AND **AES 2** inputs. Use the **Volume** control to set a comfortable listening level. Open the menu again and choose a different **Filter** if you wish.

THE SOFTWARE – THE MENU

Press "Function Step >" to move along the Menu, press "< Function Step" to move back.
Press "Function Select" to set a menu option or change options.

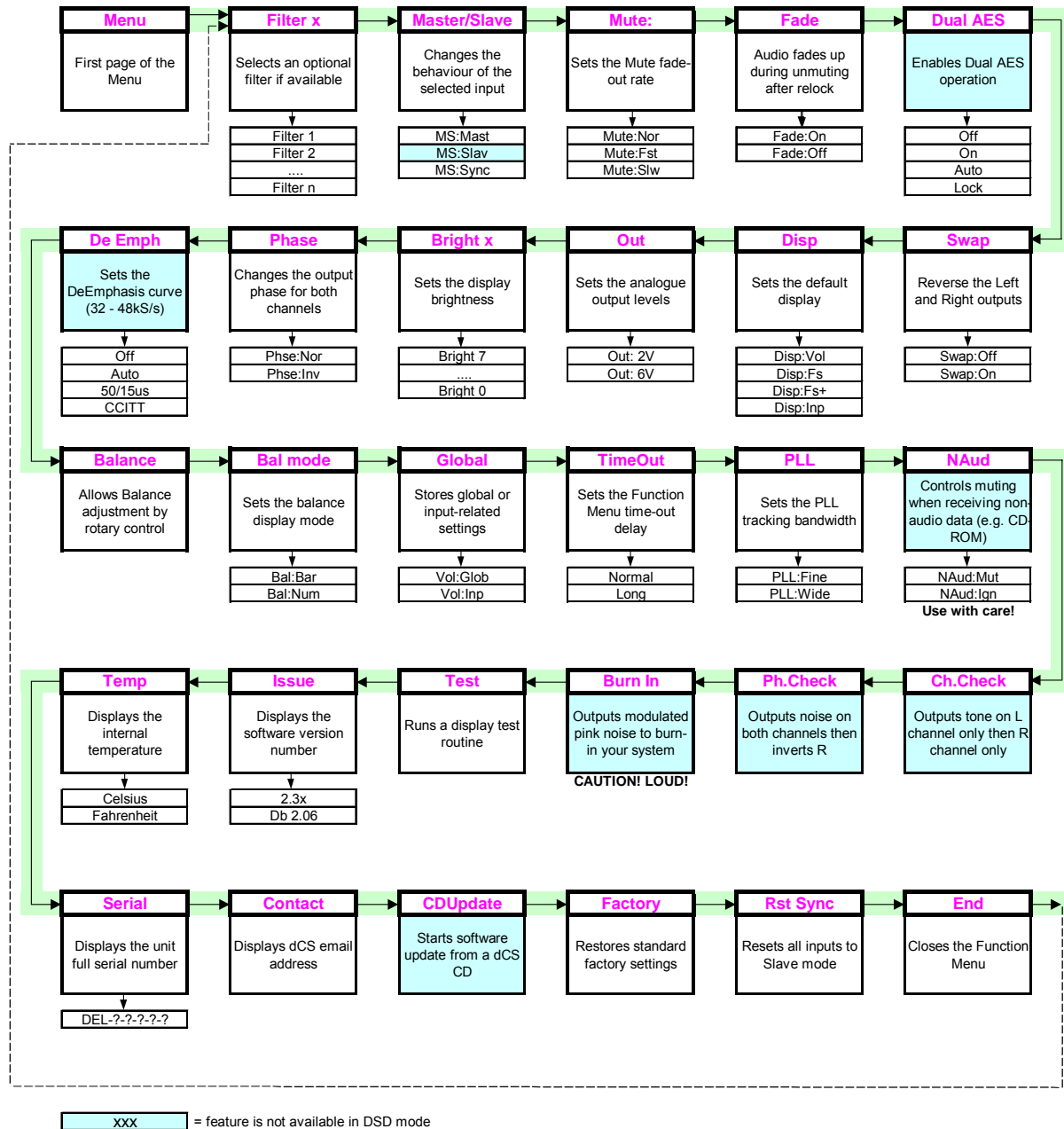

Figure 6 – Function Menu flow chart

Using the Function Menu

The Function Menu gives the user access to a wide range of additional features. It also allows new features and performance enhancements to be added at a later date by software upgrades.

Opening the Menu

The Function Menu is controlled by three buttons:

- the **Function** button opens the menu and doubles as the **Select** button.
- the **Step →** button pages forward through the Menu – referred to in the text as the **Step** button.
- the **← Step** button pages backward through the Menu – referred to in the text as the **Step Back** button.

If you have a dCS Remote Control, you can use this to access the menu:

- the **Function** button opens the Menu and doubles as the **Select** button.
- the **↑** button pages forward through the Menu - the **Step** button.
- the **↓** button pages backward through the Menu - the **Step Back** button.
- to control an Upsampler instead of a DAC, first press the **Purcell** button to turn the blue LED on.

When you first open the Function Menu, the display will show **Menu**.

Successive presses of the **Step** button page through the Menu. You cannot go directly to any particular page, but must enter at the top of the Menu and then page through until you reach the page you want.

Types of Menu Page

There are three types of page in the Menu - Parameter Pages, Information Pages and Test Pages.

Parameter pages allow the user to check and also change the current settings of the operating parameters, for example **Filter**. When a parameter page is displayed, the first press of the **Select** button shows the current setting. Subsequent presses of the **Select** button change the page setting.

Information pages display information about the unit, for example **Software Issue**. When an information page is displayed, pressing the **Select** button displays the information held on that page.

Test pages allow the user to initiate a number of useful routines, for example **Channel Check**. When a Test page is displayed, pressing the **Select** button starts the test routine.

Closing the Menu

There are two ways to close the menu and return to normal operation. The easiest way is to wait 5 seconds for the unit to time-out and revert to the standard display. Alternatively, use the **Step** button to page forward until the display shows **End** and then press the **Select** button once.

If the unit times out before the operation in hand has been completed, simply re-enter the menu, page forward (or backward) and continue where you left off. If you find the 5 second time-out difficult to use, you can extend it to 30 seconds by changing the **TimeOut** setting to **Long**.

Menu Sequence

Use the flow chart (page **20**) or the **Control Summary** sheet to guide you through the Menu more quickly.

The following explanation deals with the Function Menu pages in the sequence they occur in the Menu². The use of each page is shown on an individual basis, with the last operation being closing the Menu. After you have become more familiar with the Menu, you will find it more convenient to perform all the Function Menu operations in one go before finally closing the Menu.

Filter – Anti-Imaging Filter Setting

Delius offers a choice of 4 interpolation filters for 5 sample rates (32kS/s, 44.1kS/s, 48kS/s, 88.2kS/s and 96kS/s) and 6 for two (192kS/s and 176.4kS/s). The filters offer differing responses. In each case, Filters 1-4 are symmetrical filters (with time response before a transition the mirror image of time response after). **Filter 1** offers the sharpest cut-off, least Nyquist imaging but longest energy smear. **Filter 4** gives the gentlest roll-off (usually with significant Nyquist imaging) but the shortest transient response with least energy smear. **Filter 5** is a Gaussian filter, and **Filter 6** is an asymmetrical filter – there is almost no time response prior to the initial step.

For units fitted with a 1394 interface, DSD mode also offers four filters, but these are intended to progressively reduce the out-of-band noise level. **Filter 1** generally gives the widest bandwidth, but results are system dependent – if your system gives undesirable effects with **Filter 1**, try (in this order) **Filter 2** then **Filter 3** then **Filter 4**. These reduce the out-of-band energy at the expense of reduced bandwidth. **Filter 4** is really intended for metering applications, not for listening.

Delius remembers the last filter selection made for every sample rate. So, if you choose **Filter 4** for 96kS/s and **Filter 6** for 192kS/s, these separate settings will be stored and loaded when the incoming sample rate changes (usually when selecting a different input or changing the Upsampler settings).

Selecting a Filter

We encourage you to experiment with the filters, to find the one that sounds best for your particular application. Do not assume that one filter is best for all applications!³

do this: Assume for the purpose of this illustration that the sample rate is 96kS/s and **Filter** is currently set to **Filter 1**. Open the Function Menu and step through until the display shows **Filter 1**.

² A minor software update may change the order of the menu items or add an option. If this happens, the Control Summary sheet may be updated before the manual.

³ The reports we receive from users suggest that Filter 2 is well suited to some classical music, and that Filters 3 and sometimes 4 suit rock. Filters 5 and 6 are too new to have reports on, although the user may wish to refer to “Effects in High Sample Rate Audio Material”, by M.J.Story, R.Kelly, D.A.McLeod, M.N.Harris, presented at the 20th Tonmeister Tagung at Karlsruhe in November 1998. This paper is available from the *dCS* web-site.

do this: Press the **Select** button slowly several times. The display will in turn show: **Filter 2**, **Filter 3**, ... and finally **Filter 1** again. Select the filter you want to use then wait for the Function Menu to time-out.

There is a slight delay whilst the unit changes filters, during which it will not respond to further button presses. Selecting the most appropriate filter is simply a matter of flipping through the options as you play a CD and choosing the one that you think sounds best. Try listening for changes in imaging, ambience and low level information, bass definition and vocal clarity.

You can change filters more quickly from the listening position using the **Filter** button on the Remote Control, see page **44**.

MS – Master/Slave Operation

This is set on a per input basis, and determines whether that input acts as a master or a slave. The options available (independently, for each input) are:

MS:Slav (Slave) In slave mode (most DACs operate in this mode) the PLL locks to the incoming signal, and tracks it. This setting is not available in DSD mode.

MS:Mastr (Master) In master mode, *Delius* acts as a master clock, and outputs an autonomous 44.1kHz clock on **Wordclock Out**. This might go, for example, to a CD transport. The CD transport output is then locked to the DAC VCXO, and the DAC only has to decode the data coming in – it knows the clock frequency.

MS:Sync In sync mode, the PLL locks to a master clock (or other clock source) connected to **Wordclock In** while taking data from the selected input. The source must also be locked to the master clock, or generating the clock. If the Wordclock is not at a standard frequency, is out of capture range or is a “superclock”, the unit will display **Locking..., Fs=???** for 1 minute, then **Revert to Slave** for 10 seconds and reset itself to **MS:Slav**.

There are some restrictions on master mode operation. The source (usually a CD transport or player) must run at 44.1kS/s ONLY. *Delius* may be used in this mode with an Upsampler, but the Upsampler output must be set to 44.1kS/s, 88.2kS/s, 176.4kS/s or DSD.

Setting to Master Mode

If you wish to use master mode (we recommend this for CD transports that will accept a 44.1kHz word clock), then do the following:

do this: Connect the CD transport (or other source equipment) to *Delius* and select that input.

do this: Connect **Wordclock Out** to the wordclock input on the CD transport.

do this: Open the Menu and step through until the display shows **MS: Slav**.

do this: Press the **Select** button to change the display to **MS: Mastr**.

(Run through this sequence again if you want to change back to **MS:Slav**.)

If a source is connected and selected, *Delius* will display **d 44.1**, then **MS:Mastr** and **44.1kS/s** alternately for about 10 seconds. After that it will enable its outputs and is ready for listening.

If you are using an Upsampler set for 176.4kS/s Dual AES output, select the **Dual AES** input. The displays will then be **d 88.2**, then **MS:Mastr** and **176.4kS** alternately for about 10 seconds.

If you are using an Upsampler set for DSD output and your *Delius* is fitted with a 1394 interface, select the **1394** input. The displays will then be **Wait...**, then **MS:Mastr** and **1394** alternately for about 10 seconds.

If you attempt to use a input sample rate that is not a multiple of 44.1kS/s (for example 192kS/s), the unit will detect this and the following message will scroll across the display:

“Can’t Use Input Frequency in Master Mode. Press Button to Slave”

If you press the button mentioned in the scrolling message (**Function** for *Delius*, **Phase** for *Elgar*), the selected input will be reset to **Slav**.

If you get stuck, use the **Rst Sync** menu to reset the unit.

Mute - Mute Fade Time

This sets the length of the fade-out time before muting and the fade-in time before unmuting.

do this: Open the Function Menu and step through until you come to the **Mute** page. Press the **Select** button repeatedly and the display will cycle through:

Mute:Nor Normal muting – audio fades up and down in 0.5 seconds.

Mute:Fst Fast muting – audio fades up and down instantly.

Mute:Slw Slow muting – audio fades up and down in 2 seconds.

do this: Choose whichever you prefer and wait for time-out.

Fade – Fade Behaviour After Re-Lock

This feature fades the audio signal up gradually after locking to a source or changing inputs

do this: Open the Function Menu and step through until you reach the **Fade** page. The display shows **Fade-Off** or **Fade-On**.

do this: Press the **Select** button to toggle between these settings and wait for time out.

With **Fade** set to **On**, the unit will take longer to respond to some commands as nothing will change until the fade up / down is complete.

Dual AES – Dual AES Mode

The Dual AES interface was developed by dCS to allow 88.2 or 96kS/s data streams to be recorded on equipment designed for 44.1 or 48kS/s operation. It allows a stereo pair of 24/96 data to be recorded on a 4-track digital recorder. Dual AES mode has become a de-facto standard, appearing on an ever increasing array of products. Since then, we have developed the Dual AES interface further to operate at up to 192kS/s, doubling the available audio bandwidth a second time.

All dCS non-optical single-wire interfaces are capable of 24/96 operation, but some of our audiophile customers have told us there are extra sonic improvements to be gained from using Dual AES for 24/96 instead. The reason for this is certainly not obvious – the digits appear to be the same, it is not related to jitter.

For 24/192 operation there is no choice but Dual AES. Even our high-speed single wire interfaces are not currently fast enough.

There are certain requirements for successful Dual AES operation. Obviously, the source must generate a true Dual AES data stream, not two single AES outputs. The two cables should be similar in length (less than 3m difference). The two cables must be connected the right way around or the channels will be swapped.

Changing inputs between single wire and Dual AES may cause the DAC to default to single AES mode. To avoid this problem, the Dual AES page offers the following four options:

- Off** Disables **Dual AES** mode for when no Dual AES capable sources are in use.
- On** Allows **Dual AES** mode to be manually selected from the front panel **Input** button (see page 36) or the Remote Control, (see page 44).
- Auto** *Delius* detects single wire or **Dual AES** mode from the message flags in the data stream and sets the mode accordingly. If a Dual AES source is detected but only one wire is connected, it will lock to the source as single AES but flash either the **AES1** or **AES2** indicator to warn you that one cable is missing.
- Lock** If both **AES 1** and **AES 2** are active, selecting either AES input in this mode forces the unit into **Dual AES** mode. If only one wire is connected, the unit warns you of this by flashing the indicator for the missing wire. **Lock** mode is particularly useful when using an Upsampler – upsampling everything to 176.4 or 192kS/s Dual AES. In this case, leave *Delius* set to **Lock** mode and select inputs on the Upsampler.

IMPORTANT!

*Note that not all Dual AES capable equipment sets the message flags correctly. If this is the case, do not use **Auto** mode. You can use it with confidence on dCS equipment.*

do this: To select the **Dual AES** mode you require, open the Function Menu and step through until the display shows **Dual AES**.

do this: Press the **Select** button repeatedly and the display will cycle through the options. When you reach the one you want, wait for the menu to time out.

Swap - Swap Channels

If you have run the Channel Check test and decided the channels are reversed, you can swap the channels back digitally as follows.

do this: Assuming the unit is set for swap off, open the Function Menu and step through until the display shows **Swap:Off**.

do this: Press the **Select** button once.

The display will change to **Swap:On**.

do this: Run through this sequence again if you want to swap back.

The **Swap** setting is **NOT** remembered when you switch off. If your channels are swapped, check the wiring between units and correct the error.

Disp - Default Display

This feature allows you to choose what *Delius* displays when music is playing

do this: Open the Function Menu and step through until you come to the **Disp** page. Press the **Select** button repeatedly and the display will cycle through the following :

Disp:Vol The display reverts to Volume after time-out (e.g. **Vol -12.0**).

Disp:Fs The display reverts to Sample Rate after time-out (e.g. **44.1kS/s**).

Disp:Fs+ The display reverts to Input Bits + Sample Rate (format) after time-out (e.g. **24/192**). If receiving digital silence, 0 input bits will be correctly displayed.

Disp:Inp The display reverts to the selected input after time-out (e.g. **AES1**).

do this: Choose whichever you prefer and wait for time-out.

Out - Output Level

The Analogue Output levels should be set to suit your system – there are two levels: **6V** (high) or **2V** (low). The difference between the two settings is 9.5dB. For best results, *Delius*' volume control should be set to no lower than **-20.0** for normal listening levels with typical music. We suggest you start with **2V** and increase the level to **6V** if this is inadequate.

Before changing the output level, please ensure you are not playing music at a high level – the extra 9.5dB is noticeably louder. To change the setting (starting from **2V**):

do this: Open the Function Menu and step through until the display shows **Out: 2V**.

do this: Press the **Select** button once. The display will change to **Out: 6V**.

do this: Run through this sequence again if you want to change back to **2V**.

Bright x - Display Brightness

This adjusts the brightness of the main display, with settings between 7 (brightest) and 0 (off, unless something is touched).

do this: Open the Menu and step through until the display shows **Bright x**, where x is a number between 7 and 0.

do this: Press the **Select** button repeatedly and the display cycles through **Bright 7**, **Bright 6**,, **Bright 1**, **Bright 0** and back to **Bright 7**.

After time-out, a setting of **Bright 0** blanks the display unless the unit is not locked. Operating any control or locking to a source while in this mode turns the display back on momentarily.

Phase – Overall Phase

This option allows you to invert (reverse the phase of) both channels to correct a system phasing error.

do this: Assuming the unit is set for phase normal, open the Function Menu and step through until the display shows **Phse:Nor**.

do this: Press the **Select** button once to phase invert.

The **PHSE** indicator will light and the display will change to **Phse:Inv**.

do this: Run through this sequence again if you want to change back.

De-Emph - De-Emphasis Behaviour

Recording with high frequency emphasis is a hangover from the days of recording onto noisy magnetic tapes. To combat tape hiss, the high frequency part of the music was recorded at a higher level (pre-emphasis). The high frequency response was corrected at playback by a de-emphasis filter, reducing the hiss level as well. Digital radio also can use CCITT pre-emphasis, to help keep the bit rate down.

Some early CDs were recorded with 50/15 μ s emphasis, but more recent disks have a flat frequency response. The emphasis used during recording is encoded in message flags, buried in the data stream. On some disks, these flags are incorrect, resulting in a bumpy frequency response. *Delius* can apply de-emphasis for sources with sample rates of 32, 44.1 or 48kS/s – it is not used for 96kS/s or SACD recordings.

The options available are:

Off	Applies no de-emphasis and ignores message flags.
Auto	Automatically applies the de-emphasis curve indicated by the message flags in the data stream.
50/15us	Applies 50/15 μ s de-emphasis curve and ignores message flags.
CCITT	Applies CCITT J17 de-emphasis curve and ignores message flags.

To change the **De-Emph** setting, do the following:

do this: Open the Function Menu and step through until the display shows **DeEmph**.

do this: Press the **Select** button repeatedly. The display will cycle through the options. When you reach the required setting, wait for time-out or move on through the menu.

Usually, it is most convenient to use **Auto** mode. If the de-emphasis flag is wrong, this can be corrected manually using the other 3 settings.

Balance - Channel Balance Using Rotary Knob

This allows you to adjust the Left / Right **Balance** to centre the stereo image using the **Rotary Control**.

do this: Open the Function Menu and step through until the display shows **Balance**.

do this: Press the **Select** button once.

The display will change to either two percentages (Left and Right levels) or a bargraph type display, depending on the **Balance Mode** setting.

do this: Adjust the balance with the Rotary control.

After the Menu has timed out, the Rotary control reverts to **Volume** adjustment.

It is usually more convenient to adjust the **Balance** from the listening position using the Remote Control, see **Vol/Bal** button on page 44.

Bal Mode - Balance Information Display

Use this to select one of two types of balance display.

do this: Open the Function Menu and step through until the display shows **Bal:Bar** or **Bal:Num**.

do this: Press **Select** to change between the two.

Bal:Bar displays the channel balance as two bars, this may be easier to read from a distance:

		Balance Central
		Balance to left
		Balance to right

Bal:Num displays channel balance as two percentages:

100%	100%	Balance central
100%	0%	Balance to left
0%	100%	Balance to right

Global – Global/Local Volume

Delius can store **Volume** settings in two ways:

- Applying the same **Volume** setting to all inputs (**Global** volume).
- Using different settings for each input (Local volume, or **Input** specific). This is useful where the average loudness (and so the preferred **Volume** setting) changes from source to source.

To change this setting:

do this: Open the Function Menu and step through until you reach the **Vol** page. The display shows **Vol:Glob** or **Vol:Inp**.

do this: Press the **Select** button to choose one of these settings and wait for time out.

TimeOut – Menu Time Out Setting

If you find the 5 second time out period for the menu is too short, use this option to change the time out period to 30 seconds.

- do this: Open the **Menu** and step through until the display shows **Timeout**.
- do this: Press the **Select** button once and the display will show **Normal**.
- do this: Press the **Select** button again and the display will change to **Long**.
- do this: Repeat this if you want to change back.

PLL - PLL Tracking bandwidth

In slave mode, the PLL (Phase Locked Loop) synchronises *Delius*' internal crystal clocks to the incoming data stream. The system runs through two different modes while locking. The final mode (fine lock) has a very narrow bandwidth which rejects jitter generated by the source. This is the normal PLL setting and gives best results with a stable source. It takes about 6 seconds to lock.

Some CD players (even some very expensive ones!) generate a high level of jitter and this can cause *Delius* to intermittently lose fine lock and mute the **Analogue Outputs**. This menu option forces the PLL to stay in a wide-band mode, allowing it to track larger variations in the source sample rate. In this mode, the unit locks in less than 100 milliseconds.

To change the setting:

- do this: Open the Function Menu and step through until the display shows **PLL: Fine** or **PLL: Wide**.
- do this: Press the **Select** button to change between these two settings. Select **PLL:Wide** if you are having locking problems.

If you are using *Delius* in master mode or with a Master Clock, the PLL should be set to **PLL:Fine**, otherwise the jitter improvement will be lost.

NAud - Non Audio Muting

Delius is normally set to mute if the Non-Audio message flag in the incoming data stream is On – identifying the source as a corrupt data stream, CD-ROM or other non-audio format.

We have found that some audio CDs actually have the Non-Audio flag set! To listen to such disks, the automatic muting must be **TEMPORARILY** disabled.

IMPORTANT!

*Listening to a CD-ROM is very unpleasant and can cause damage to your ears, power amplifier and loudspeakers. Use this mode with care. You should turn Non-Audio Muting back on as soon as possible – we advise you not to leave *Delius* in this mode.*

Override Non-Audio Muting

The most convenient way to over-ride the Non-Audio muting for individual tracks is as follows.

- do this: When **NonAudio** is displayed, press the **Mute** button. *Delius* will play the track normally. Press the **Mute** button again to mute the outputs and restore Non-Audio muting.

The over-ride is cancelled at power down or when the unit re-locks, avoiding the risk that the unit will be left for extended periods without protection.

Disabling Non-Audio Muting

If for some reason, you need to disable Non-Audio muting for longer periods, you can turn it off in the Function Menu as follows.

- do this:** Open the Function Menu and step through until the display shows **NAud:Mut**.
do this: To ignore the non-audio flag, press the **Select** button once and the display will change to **NAud:Ign**.

Delius is now set to ignore non-audio message flags – and your protection against playing non-audio data is removed. When powered up in this mode, “**Ignoring Non-Audio Flag**” scrolls across the display to warn you.

Restoring Non-Audio Muting

To turn non-audio muting back on:

- do this:** Open the Function Menu and step through until the display shows **NAud:Ign**.
do this: Press the **Select** button once and the display will change to **NAud:Mut**.

Ch.Check - Channel Check Test

Use this feature to check if the stereo outputs on your system are swapped. It is disabled when in DSD/SACD mode.

- do this:** Set up your system to play music at a comfortable level.
do this: Open the Menu and step through until the display shows:

Ch.Check

- do this:** Press the **Select** button once to start the test. After briefly displaying **Wait**, the following sequence occurs:

Left

A modulated tone should appear on the left channel only for several seconds.

None

Both outputs are muted for a second.

Right

A modulated tone should appear on the right channel only for several seconds.

Done

This is displayed briefly at the end of the test.

If the channels are swapped, check for wiring errors from the unit output onwards. If you correct this temporarily using the **Swap** function on a *dCS* DAC, note that the **Swap** setting is **NOT** remembered at power down.

Ph.Check - Phase Check Test

Use this feature to check if one channel in your system is phase inverted⁴. It is disabled when in DSD/SACD mode.

- do this:** Set up your system to play music at a comfortable level.

⁴ The ear responds to positive pressure substantially more than it does to negative pressure for low frequencies, so it is worth getting the phasing correct.

do this: Open the Menu and step through until the display shows:

Ph.Check

do this: Press the **Select** button once to start the test.

After briefly displaying **Wait**, the following sequence occurs:

Normal

In-phase noise appears on both channels for several seconds.

None

Both outputs are muted for a second.

Inverted

A second burst of noise appears on both channels with the right channel inverted for several seconds.

Done

This is displayed briefly at the end of the test.

If both channels are in-phase the first burst of noise will produce a stable central image but the second burst will not. If one channel is out of phase, the second burst will produce a stable stereo image but the first will not.

If there is a phasing error, check for wiring errors from the unit output onwards. You cannot correct this error on a dCS DAC using the **Phase** feature as this inverts both channels.

Burn In - Burn-In Signal Generation

IMPORTANT!

Read all the steps in this section before starting the System Burn-in routine. The Burn-in routine outputs a signal at maximum volume.

IMPORTANT!

This routine is NOT suitable for burning-in loudspeakers. Ensure your loudspeakers are disconnected, or your power amplifier is switched off before starting this routine.

Use this feature to burn-in your system components with modulated pink noise. It is disabled when in DSD/SACD mode.

do this: Set up your system volume control to the usual setting.
do this: Open the Menu and step through until the display shows:

Burn In

do this: Press the **Select** button once to start the burn-in routine.

Delius will show the warning messages **Caution** and **Loud** in the main display for 20 seconds and then the burn-in signal will ramp-up from zero to maximum level over a period of about 10 seconds.

The display cycles through **Burn in**, **Caution** and **Loud** while the **Burn In** routine is running.

do this: To stop the Burn-in signal, press either a **Step** or **Select** button once. The display will briefly show:

Done

Test - Display Test

This runs a test routine to ensure the display is working correctly.

do this: Open the Menu and step through until the display shows **Test**.

do this: Press the **Select** button once to start the test.

- The main display lights up then fades from bottom to top.
- The indicator LEDs light up briefly in sequence.
- All indicators light up, along with small squares on the main display. This flashes off and on once.
- The display shows **Done**.

Issue – Software Issue State

This displays the issue number of the software fitted to your unit. You will need to check this if you are considering a software upgrade or if your unit malfunctions.

do this: Open the Menu and step through until the display shows **Issue**.

do this: Press the **Select** button once to display the software issue.

do this: For units fitted with a **1394** interface, press the **Select** button again to display the 1394 interface software issue.

Temp – Unit Internal Temperature

This displays the temperature inside the unit, close to the crystal oscillators.

do this: Open the Menu and page through until the display shows **Temp**.

do this: Press the **Select** button once to display the temperature in degrees Fahrenheit. Press **Select** again to change to degrees Celsius.

Serial – Unit Serial Number

This displays the full serial number, including the hardware configuration code. We will need this information to assemble upgraded software to suit your unit.

do this: Have a pen and paper handy to note down the number. Open the Menu and step through until the display shows **Serial**.

do this: Press the **Select** button once and the serial number will scroll across the display.

Contact - Contact information

This displays dCS' email address and web-site URL.

do this: Open the Menu and step through until the display shows **Contact**.

do this: Press the **Select** button once and the contact information will scroll across the display.

CDUpdate – Software Update By CD

Current software for *dCS Elgar Plus*, *Elgar*, *Delius* or *Purcell* and all *Verdi*, *La Scala* or *Verona* software features a **CD Update** menu page. You can update the software inside any of these products loaded with **CD Update** software quickly and easily from a CD supplied by *dCS*.

IMPORTANT!

Please follow the latest update instructions supplied with the CD. The following is for guidance only.

You will need a standard CD Transport, a CD player or a *dCS Verdi* to play the CD. A few CD players are not suitable because they upsample to 48kS/s or change some of the data bits in other ways (one example is the ML37). Don't worry - the CD Update routine detects these and stops, preventing any changes to the internal software.

If you are updating a *dCS* Upsampler or DAC:

do this: Connect an AES or RCA digital output from the Transport to the Upsampler or DAC and select the input you have just connected. Disconnect any **1394** interface cables.

If you are updating a *dCS* DAC connected to the Transport through another device:

do this: Connect an AES or RCA digital output from the other device to the DAC and select the input you have just connected. Set the other device to bit-for-bit mode (**Cloning** on a *dCS* Upsampler). Disconnect any **1394** interface cables. If in doubt, connect the DAC directly to the transport.

If you are updating a *dCS Verona*:

do this: Disconnect ALL cables from the unit, except the power cable. Open the Menu on the unit to be updated and step through until the display shows **CDUpdate**.

do this: Make sure the transport is in **STOP** mode.

do this: Press the **Select** button to start the routine.

do this: When the unit displays **Green**, connect a BNC cable from the **Ext Ref In** input to a BNC SPDIF digital output on the transport. The unit will lock to the transport, then display **Wait**.

If you are updating a *dCS* Transport, the Transport plays the CD and updates itself, missing out some of the early steps. Disconnect any **1394** interface cables.

For all *dCS* units:

do this: **RELAX!** The update procedure is easy.

do this: Mute your power amplifier.

do this: Insert a *dCS* CD (containing software for the unit you want to update) into the transport, making sure it is in **STOP** mode.

do this: Open the Menu on the unit to be updated and step through until the display shows **CDUpdate**.

do this: Press the **Select** button to start the routine.

The unit will display **Wait** while it prepares the flash memory for the update. After 3-4 minutes, the unit will scroll **Please Start CD**.

do this: Press **PLAY**.

IMPORTANT!

*Do not press **PLAY** before the unit to be updated is ready. This can cause the download to fail. Use only *dCS* CDs.*

The unit will now inspect the CD, and will display **Scanning**, while it reads administrative data.

If there is anything wrong with the dCS CD that has been loaded or it does not match the product, the unit will display **Wrong!** or **Wrong CD** or **No Index** and revert to normal operation. Don't worry – the internal software is unchanged. Check the CD for dust or scratches.

If it is not a dCS CD at all, the unit will keep repeating **Please Start CD**, for about 30 seconds or display **Wrong CD** and then revert to normal operation.

If the data is correct, the unit will display **Track n**, where n is a number.

do this: You can move the Transport on to track n, or wait for it to get there of its own accord.

If the unit has to wait for the right track, it will display **Found Track 1**, then **Found Track 2**, etc, until it finds the right one. **Vx.xx** will appear on the display (this is the new software issue number). If the unit displays **No Track**, repeat the procedure but manually advance the transport to track n.

Next, the update progress is displayed in one of the following formats:

- The display counts up from **0% 0/7** to **99% 0/7**, displays **Copying**, counts up from **0% 1/7** to **99% 1/7**, displays **Copying** and so on until the last section is loaded and copied. Some models may use less than 8 sections.
- A moving dot counts down slowly from about **3** to **0**.

After about 15 minutes, the update is complete and the unit will reboot itself.

do this: If the CD is still playing, you can stop it now.

do this: If the unit being updated has a 1394 interface, wait until the unit has settled (about 30 seconds), switch it off for 10 seconds, then on again.

If the unit detects no change in the 1394 interface code, it will boot up as usual and be ready for use.

If the 1394 interface code has been updated, the unit will load the new code into the flash memory on the 1394 interface board – **this takes about 10 minutes**. While this is taking place, the unit will display a progress bar. Next the unit will display in sequence: **Done 5**, **Done 4**, ..., **Done 1** then reboot itself again.

The unit is ready for use.

OOPS!

If the CD transport stops or becomes disconnected during an update, don't worry! The original software is backed up inside the unit. Proceed as follows:

The checking routine will find a sequencing error and **Non Seq** or **Bad CD!** will appear on the display.

do this: Turn the power off and on to reboot. This message will scroll across the display:
Bad CheckSum – Press Function button to attempt recovery
or **Bad CheckSum – Press Mute button to attempt recovery**
or **Bad CheckSum – Press Menu button to attempt recovery,**

depending on the model.

do this: Press the appropriate button once.

The original software is retrieved from the internal backup while displaying **Wait...** . This may take a few minutes. When recovery is complete, the unit re-boots.

do this: Run the **CD Update** routine again to load the new software.

Factory – Restoring Factory Defaults

This feature sets most of the parameters back to the factory default settings. This can be useful if the settings are accidentally changed and you need to reset the unit to a standard configuration, or your children play with it.

do this: Open the Menu and step back until the display shows **Factory**.

do this: Press **Select** and leave the menu to time out.

After a few seconds, the unit will re-boot and return to normal operation set up as follows:

- **Input** to **AES1**. The **Input** selection is automatic if the unit is connected by a 1394 cable to another dCS unit with current software.
- **Filters** to **Filter1**
- **Phase** to **Normal**
- **Swap** to **Off**
- **Master/Slave** to **MS:Slav** on all inputs
- **Brightness** to **Bright 4**
- **Display** to **Fs+**
- **Mute** to **Off, Normal** speed
- **Dual AES** to **Auto** if an Upsampler is detected, otherwise **Off**
- **Fade** to **On**
- **De-Emphasis** to **Auto**
- **Balance** to **centre**
- **Balance display** to **Bal:Num**
- **Volume** to **-30, Global**
- **Timeout** to **Normal**
- **PLL mode** to **Fine**
- **Non-Audio** to **Mute**
- **Delius** only: **Output level** to **Out :2V**
- Other settings as you last used them.

Rst Sync – Setting all Inputs to Slave Mode

This feature resets the 1394 input to **Sync** mode and all other inputs to slave mode. This can be useful if you have problems setting master mode, or your children play with it.

do this: Open the Menu and step through until the display shows **Rst Sync**.

do this: Press **Select** and leave the menu to time out.

The display will show **Reset**. After a few seconds, the unit will re-boot and return to normal operation set up as follows:

- **Master/Slave** to **MS:Sync** on 1394 input
- **Master/Slave** to **MS:Slav** on all inputs except 1394
- Other settings as you last used them.

THE HARDWARE – CONTROLS AND CONNECTORS

Front Panel

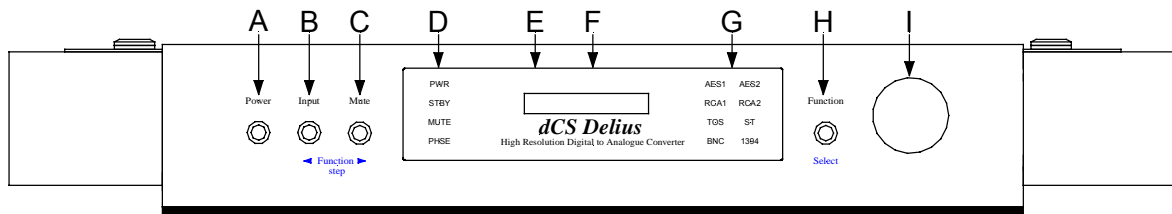

Figure 7 – dCS Delius Front Panel

Key to Front Panel

A	Power / Standby button
B	Input selector or Step Back button
C	Mute or Step button
D	Status indicator
E	Remote Control sensor
F	Main Display
G	Input indicator
H	Function or Select button
I	Rotary control

Power Button

This button doubles as a power on / off switch and a standby mode switch.

do this: To switch on, press the **Power** button briefly. If power is available, the **PWR** indicator will light and *Delius* will run through the power up routine.

Note that the **Power** button will not click when turning power on – this is normal.

do this: When you have finished listening, press the **Power** button briefly to set the unit to standby mode.

The Analogue Outputs will mute, all displays will turn off except the **PWR** and **STBY** indicators. In this mode, *Delius* uses less power but stays warm.

do this: To restore normal operation, press the **Power** button briefly again.

The **STBY** indicator will turn off and *Delius* will power up ready for use.

do this: To switch off completely, press the **Power** button and hold it for a few seconds until the **Main Display** shows **Power Dn**, then release it.

Input Button

(Step Back)

The **Input** button controls which digital input is selected, as shown by the **Input** Indicator.

do this: Press the **Input** button repeatedly until the required input is shown on the **Input** indicator.

The choices for a standard *Delius* are **AES1** (XLR), **AES2** (XLR), **Dual AES** (AES 1 + AES 2 simultaneously on 2 x XLR), **RCA1**, **RCA2**, **Toslink** or **BNC**. **Dual AES** is available only if both **AES1** and **AES2** inputs are connected to a Dual AES source.

An IEEE **1394** interface is available as an option. Use the **Input** button to select one of the sources connected to the 1394 interface.

The **Input** button doubles as the Menu **Step Back** button, used for paging backwards through the Function Menu (see page **21**).

Mute Button

(Step)

do this: If the unit is locked to a digital source, press the **Mute** button to mute or unmute the Analogue Outputs. The **Mute** indicator will light when the outputs are muted.

If the unit is not locked to a digital source, the Analogue Outputs are automatically muted, the **Mute** indicator is lit and the **Mute** button has no effect.

do this: See **NAud** on page **29** if you need to over-ride an incorrectly set Non-Audio flag on a disk or tape.

The **Mute** button doubles as the **Step** button, used for paging forwards through the Function Menu (see page **21**).

Status Indicator

This consists of 4 indicators:

- **PWR** is lit when power is connected and the unit is turned on.
- **STBY** is lit when the unit has been placed in Standby mode. The **PWR** indicator will also be lit but all other indicators and controls will be inactive. The Analogue Outputs will be muted and the unit will be operating in a reduced power, “keep warm” condition. To return to normal operation, press the **Power** button. If power is turned off or fails, Standby mode is cancelled.
- **MUTE** is lit whenever the Analogue Outputs are muted. This occurs if you have pressed the **Mute** button during normal operation or if the unit is not locked to a digital source (displaying **No Input**). If a non-audio source such as a CD-ROM is being played, *Delius* will normally mute automatically to protect your ears, power amplifier and loudspeakers.
- **PHSE** is lit if the phase of the Analogue Outputs has been inverted by changing the **Phse** setting in the Menu, see page **27**.

Remote Control Sensor

Point the end of the **Remote Control** unit towards the sensor for best control range.

Main Display

The main display tells you what *Delius* is doing.

- When not locked to a digital source, the display shows **No Input**.
- During normal operation, the display will show Volume (**Vol**), Sample Rate (**Fs**), Wordlength & Sample Rate (**Fs+**) or Input (**Inp**), depending on the setting of the **Display** menu option, see page **26**.
- While locking to a source, the display shows in sequence **Locking**, followed by **d xxx** (detecting the base sample rate) and finally the normal display.
- When adjusting the **Volume** setting, the display changes to **Vol -xx.x** It changes back to the normal display 5 seconds after the last change.
- When adjusting the **Balance** setting, the display changes to either **xxx% xxx%** or a double bar. The **Balance** display mode is set by the **Bal** item in the Menu, see page **28**. The display changes back to normal 5 seconds after the last change.
- When accessing the Function Menu (see page **20**), menu options are displayed here.
- If an error occurs during power up or normal use, the details of the fault will be displayed. See "Fault Indication" on page **64**.

Input Indicator

This bank of indicators shows which digital input is selected.

For **Dual AES** operation, both **AES1** and **AES2** indicators will be lit at the same time.

Function Button

(Select)

Press the **Function** button to open the Function Menu (see page **21**) and change or select settings in the menu.

Rotary Control

This control is dual function. In normal use, it sets the **Volume** or **Balance**, but while the menu is open, it scrolls through that. The rotary control has no end stop – it will turn continuously.

The **Volume** and **Balance** functions are implemented digitally. For best results, set the **Volume** to a fairly high level (say between **-20.0** and **-10.0**) while playing music at typical listening levels. If using a preamplifier Volume control instead, set *Delius* **Volume** to 0.0 (maximum).

Rear Panel

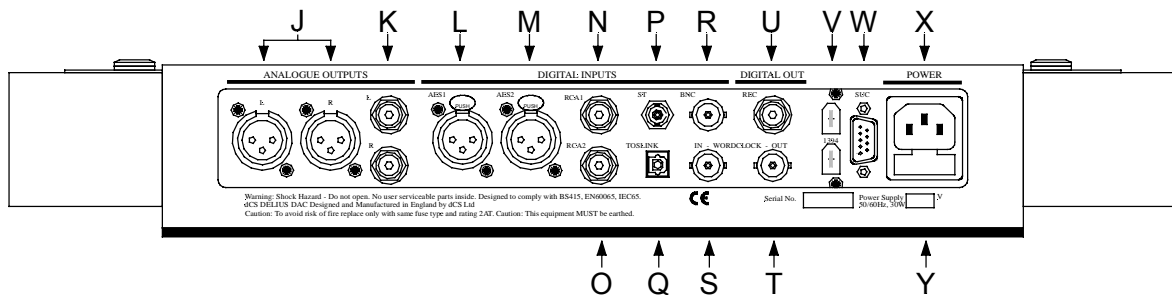

Figure 8 – dCS Delius Rear Panel

Key to Rear Panel

J	Balanced Analogue Outputs L & R on XLR male connectors
K	Unbalanced Analogue Outputs L & R on RCA phono connectors
L & M	AES/EBU digital inputs AES 1 & AES 2 on XLR female connector
N & O	SPDIF digital inputs RCA1 & RCA2 on RCA phono connectors
P	Spare
Q	SPDIF optical input on Toslink connector
R	SPDIF digital input on BNC connector
S	Wordclock digital Input
T	Wordclock digital Output
U	SPDIF digital output REC on RCA phono connector
V	Optional IEEE 1394 interface on two 6-way connectors
W	SUC - Software Upgrade Connector, 9-way male 'D' type connector
X	IEC Power inlet
Y	Mains fuse holder

(Upgrader's note: Units manufactured before February 2001 were fitted with **Wordclock In**, but this was labelled **OPTION**. This location was blanked off on some early units.)

Balanced Analogue Outputs

If your pre or power amplifier has balanced inputs, connect *Delius'* **Balanced Analogue Outputs** to them. For best results, connection of these outputs to unbalanced inputs is not recommended – use the **Unbalanced Analogue Outputs** instead. Use good quality, screened, XLR audio cables.

Unbalanced Analogue Outputs

For unbalanced equipment, use the **Unbalanced Outputs** with good quality, screened, RCA phono audio cables. The **Unbalanced Outputs** are very high quality! It is much better to use these for equipment with a single-ended input, than to use half of a balanced output. Doing so may cause ground loop hum pickup.

AES/EBU Digital Inputs

The **AES 1** and **AES 2** inputs may be used individually for digital signals with sample rates up to 96kS/s. The data format is AES3.

In **Dual AES** mode, both inputs must be used together. The **Dual AES** interface allows a 192, 176.4, 96 or 88.2 kS/s 24 bit signal to be encoded as two standard 96, 88.2, 48 or 44.1 kS/s 24 bit AES data streams respectively. *Delius* decodes the dual data stream and converts it to wide band analogue. See **Dual AES** on page **25** for more information.

IMPORTANT!

*Please ensure the two AES inputs are correctly connected to the source for Dual AES operation or the channels will be swapped. This usually involves connecting AES 1 (or AES A) on the source to **AES 1** on *Delius* and AES 2 (or AES B) on the source to **AES 2** on *Delius*.*

Use with 110 ohm screened, twisted pair cable designed for digital audio or RF. Do not use unscreened cables as they may pick up interference from other appliances.

SPDIF Digital Inputs

The **RCA1**, **RCA2** and **BNC** inputs are used individually for digital signals with sample rates up to 96kS/s. The data format is IEC60958, otherwise known as SPDIF. RCA connectors are the type commonly found on consumer equipment.

Use with 75 ohm co-axial cables designed for digital audio or RF use. Some types of audio cable are not suitable and may cause crackling noises or other malfunctions.

Toslink and ST Optical Inputs

The **Toslink** and **ST** inputs are used for optically transmitted digital signals with sample rates up to 48kS/s. In practice, the interfaces are tested up to 96kS/s but *dCS* cannot guarantee this with non-*dCS* source equipment. The data format is IEC60958, otherwise known as SPDIF.

Use the Toslink input with Toslink fibre optic cables designed for digital audio use. Use the ST input with ST style fibre optic cables. Pull off the plastic cover before use.

REC Digital Output

The **REC** output buffers and loops through the selected single wire input data with sample rates up to 96kS/s. The data format is the same as the selected input (i.e. AES3 or IEC60958), the electrical format is SPDIF. It may be connected to a digital recorder or another DAC. Use with 75 ohm co-axial cables designed for digital audio or RF use.

IMPORTANT!

*This output is intended for use with Single AES, RCA, BNC, Toslink or ST inputs **ONLY**. If the selected input is in any other format, the **REC** output will carry either the left channel data or full scale noise.*

IMPORTANT!

*If the selected input is SPDIF and the Copy Prohibit flag in the source data is set, the **REC** output will be the same and you will not be able to record the data.*

1394 Interface

Units fitted with an IEEE **1394** multi-channel interface feature two 6-way 1394 connectors. The active source is selected by the **Input** button, see page **36**.

In this release, the unit accepts DSD data at 2.822MS/s from either **1394** connector. For correct operation, the source must generate a 44.1kHz wordclock (or be locked to a master clock running at 44.1kHz) and this must be connected to *Delius*' **Wordclock In** connector. We recommend using the 1.8 metre long, 6-way IEEE 1394 cable assembly and the BNC cable assembly provided. See the "IEEE 1394 Overview" section on page **50** for more information.

Wordclock Digital Input / Output

The **Wordclock Input** accepts a Wordclock at sample rates up to 96kS/s. It allows *Delius* and your source equipment (e.g. CD or DVD player) to be synchronised to a master clock. This arrangement helps reduce jitter, which can degrade the audio output. See the **MS** menu page on page **23** for details.

The **Wordclock Output** is intended to synchronise other equipment to *Delius*. In Master mode, the unit outputs a 44.1kHz master clock for other equipment to lock to. In Slave or Sync modes, this output is disabled. See the **MS** menu page starting on page **23** for more details.

There is no data on the **Wordclock** interface. Use with 75 ohm co-axial cables designed for digital audio or RF use.

SUC

The Software Upgrade Connector is intended to be used by *dCS* service agents to load new software into *Delius*.

IMPORTANT!

*Do not connect any other equipment to the SUC connector as this may damage both *Delius* and the equipment so connected. Do not operate *Delius* with a PC connected. Failure to observe this warning will void the unit's warranty, and may cause unpleasant effects in your system.*

IEC Power Inlet

Use with a 3 - pin IEC type power cable.

Mains Fuse

Replace only with a 20 x 5mm 0.5A T HRC fuse. Please see page **60** for replacement details.

Additional Information

The rear panel displays the following information about the unit:

- Supply voltage setting, frequency range and rated power.
- Model: *dCS Delius*
- The short form of the unit serial number.

We will need the serial number (preferably the full serial number from the menu) to give you support over the phone, or to ship you software updates.

Remote Control

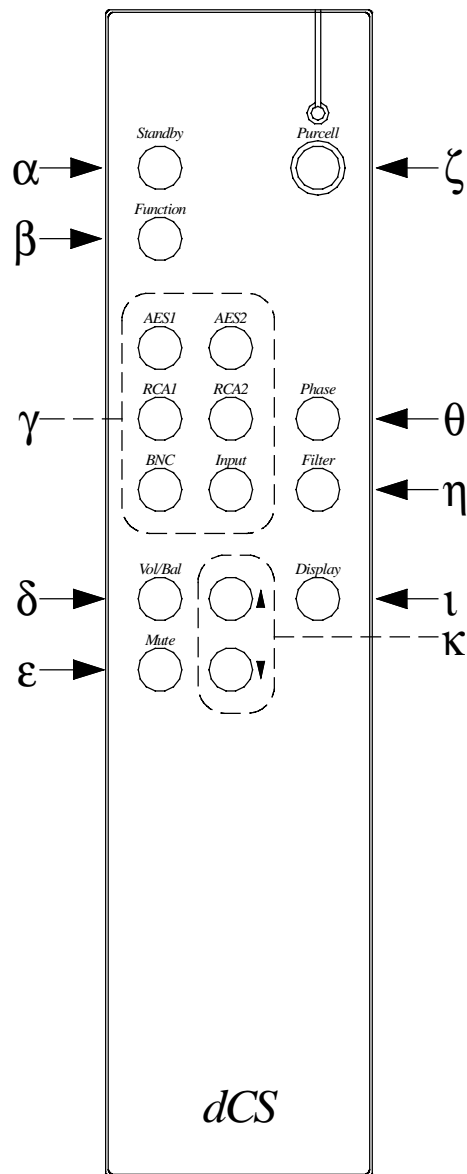

Figure 9 – The Remote Control

Standby Button

(α) Puts *Delius* in Standby mode – this saves energy but keeps the unit warm and ready for use. Press again to return to normal operation.

Function Button

(β) Opens the Function Menu (see page 21). Use the \uparrow and \downarrow buttons (κ) to page through the menu and press **Function** again to change a setting. Note that the menu may time out if there is no activity for 5 seconds.

Input Selector Buttons

(γ) Select individual inputs with the **AES1**, **AES2**, **RCA1**, **RCA2** & **BNC** buttons. The **Input** button steps through all the available inputs in sequence, giving access to those without an individual button. For **Dual AES**, connect a suitable source, select **AES2** and press the **Input** button.

Vol/Bal Button

(δ) Switches between **Volume** mode and **Balance** mode. Use the \uparrow and \downarrow buttons (κ) or the Rotary Control on the front panel to alter the settings. **Balance** mode times out after 5 seconds, reverting to **Volume** mode.

Mute Button

(ϵ) Press this to mute or unmute the Analogue Outputs.

Purcell Button and LED

Purcell units fitted with software version 1.20 or later and all *Grieg* units will accept commands from the Remote Control. Press the **Purcell** button (ζ) and the blue LED will light up for about 5 seconds. During this time, the **Standby**, **Function**, **Input** selector, **Filter**, \uparrow , \downarrow and **Display** buttons will control the Upsampler instead of *Delius*.

Sending a *Purcell* command will keep the Remote Control in *Purcell* mode (and the LED on) for another 5 seconds. Press the **Purcell** button again while the blue LED is lit to return to *Delius* mode (or just wait 5 seconds).

If the blue LED is on, the Upsampler will respond. If it is off, *Delius* will respond.

Phase Button

(θ) Changes the Phase of the analogue outputs to **Inverted**. The **Phase** indicator on the Front Panel will light. Press again to return to **Normal**.

Filter Button

(η) Changes the interpolation filter setting, giving a different trade-off between Nyquist image suppression and energy smear. Each sample rate has a separate Filter setting stored, so *Delius* must be locked to a suitable source before the Filter setting can be changed. This feature is duplicated in the Menu, see **Filter** on page **22**.

Display button

(ι) Each press reduces the display brightness on a scale from **Bright 7** to **Bright 0**.

Up and Down (\uparrow / \downarrow) buttons

Use these buttons (κ) to change **Volume** and **Balance** settings or scroll along the Function Menu, see page **21**.

DELIUS TECHNICAL INFORMATION

Converter Type

- 5-bit, approximately 3MS/s oversampled, dCS patented *Ring DAC* topology.

Digital Interface Specifications

AES/EBU (AES3)		Inputs	
Type		<i>Balanced, differential</i>	
Impedance		110	Ω
Sensitivity (unloaded)		1 ~ 10	V pk-pk
Maximum Wordlength		24	bits
Connectors		XLR3 female (2)	
Connections	Pin 1	Ground or shield	
	Pin 2	+Signal	
	Pin 3	-Signal	

Table 1 – AES/EBU Interface Electrical Characteristics

SPDIF (electrical)		Input	REC Output
Type		<i>Single ended, ground referred</i>	
Impedance		75	75
Sensitivity (unloaded)		0.5	1.0
Maximum Wordlength		24	24
Connectors		RCA Phono & BNC	RCA Phono

Table 2 – SPDIF Interface Electrical Characteristics

SPDIF (optical)		Toslink Input	ST Input
Type		<i>Optical</i>	
Wavelength		660	850
Maximum Wordlength		24	24
Connector		Toslink	ST
		EIAJ CP-340	(if fitted)

Table 3 – Optical Interface Electrical Characteristics

SDIF / Wordclock		Input	Output
Type		<i>Single ended, ground referred</i>	
Impedance		100	25
Sensitivity (unloaded)		TTL	TTL
Connectors		BNC	BNC

Table 4 – SDIF / Wordclock Interface Electrical Characteristics

IEEE 1394	I/O
Type	<i>High speed, multi-channel</i>
Data format	<i>dCS encrypted DSD</i>
Connectors	6-way (2)

Table 5 – IEEE 1394 Interface Electrical Characteristics

Sample Rates

- 32, 44.1, 48, 88.2 or 96kS/s on single wire interfaces and SDIF-2 / **Wordclock Input**, auto selected. Optical inputs are not guaranteed at 88.2kS/s and 96kS/s.
- 88.2, 96, 176.4 or 192kS/s on **Dual AES** interface, auto selected.
- 2.822MS/s for DSD, requires a 44.1kHz wordclock.
- 44.1kHz for **Wordclock Output** in master mode, not temperature compensated.

Frequency Response (set to Filter 1)

- Fs=32kS/s +/-0.1dB, 10Hz to 15kHz
- Fs=44.1 or 48kS/s +/-0.1dB, 10Hz to 20kHz
- Fs=88.2 or 96kS/s +/-0.1dB, 10Hz to 35kHz
- Fs=176.4 or 192kS/s +0.25/-0.35dB, 10Hz to 55kHz⁵
- DSD +0.2/-0.35dB, 10Hz to 55kHz

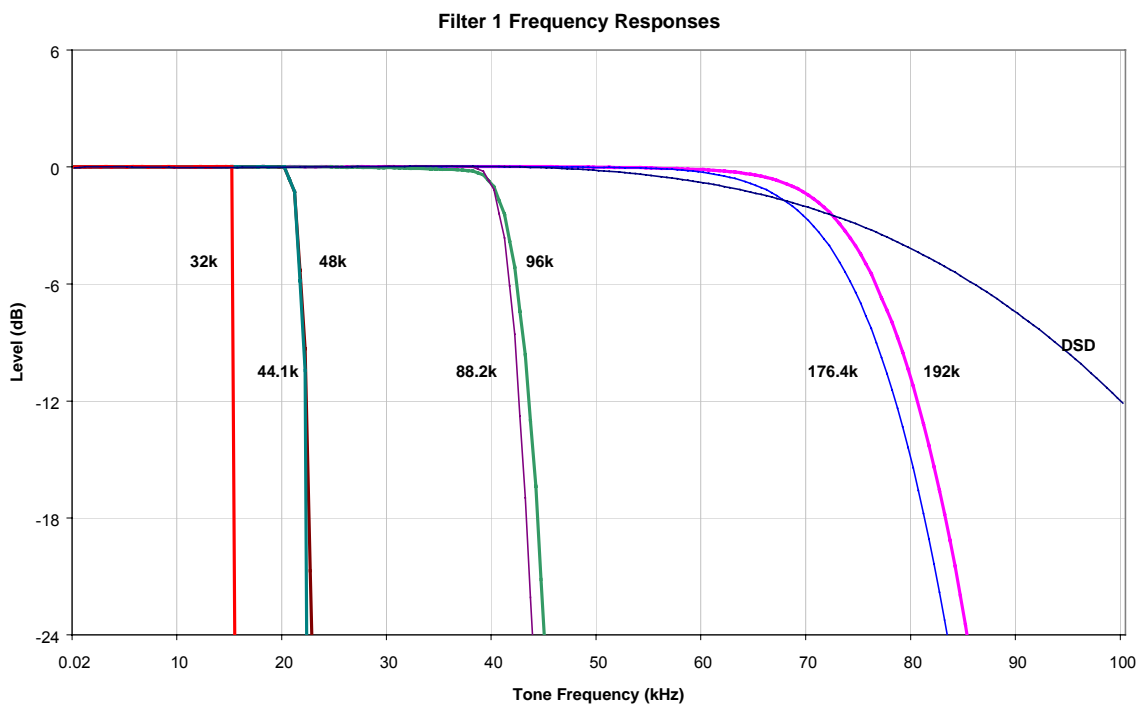

Figure 10 – Frequency responses at all sample rates, set to Filter 1

⁵ The point of high sample rates is not to have a ruler flat response with a brick-wall filter. The roll-off is deliberate. See for example “Effects in High Sample Rate Audio Material” by M.J.Story, R.Kelly, D.A.Macleod & M.N.Harris, presented at the 20th Tonmeister Tagung at Karlsruhe in 1998.

Volume Control

- Digitally implemented, 0 to –60dB in 0.5dB steps

Balance Control

- Digitally implemented, 0 to –40dB in variable steps, each side.
- Mutes one channel at minimum settings.

De-Emphasis

- Auto-selected, 50/15µs, CCITT J17 or none, available at 32, 44.1 or 48kS/s.

Analogue Outputs

Type	Balanced	Unbalanced	
	<i>Balanced, not floating</i>	<i>Single ended, ground referred</i>	
Source impedance (20Hz-20kHz)	< 1Ω + 100µH	< 1Ω + 100µH	
Maximum load	600	600	Ω
Noise, unweighted (20Hz-20kHz)	< -110	< -105	dB0
Spurious responses (20Hz-20kHz)	< -100	< -100	dB0
L-R crosstalk, (20Hz-20kHz)	< -90	< -90	dB
Level for full scale (set by the Out menu)	6 or 2	6 or 2	V rms
Connectors	XLR male (2)	RCA Phono (2)	
Connections	+Signal on pin 2 -Signal on pin 3	-	

Table 6 – Analogue Output Electrical Characteristics

Clocking

The sample clock quality significantly determines the output performance of the converter. The highest quality clocks that are available are crystals, so we use these. *Delius* uses two on-board voltage controlled crystal oscillators (VCXO's) as clock sources - one for the 44.1kS/s related outputs and one for the 48kS/s related outputs.

Only one VCXO is active at a time. In slave mode, the active VCXO is synchronised to the clock signal extracted from the input by a phase locked loop (PLL). This PLL is of a special narrow bandwidth type, that provides a significant degree of "clock cleaning". The PLL is also very robust, and will lock to very poor signals if necessary. Data is decoded using a much wider band (faster) PLL, so AES3 type low frequency jitter on the input clock can be handled, and will be cleaned.

Synchronising to source

Pull-in range	± 300 ppm about nominal frequency
Lock-in time	< 6 seconds for most situations

Power requirements

Units may be set for 100, 115/120, 200, 215/220 or 230/240V (+/-10%), 50/60Hz AC operation.

	Typical power consumption	Maximum power consumption
<i>Purcell & Verona</i>	16W	20W
<i>Delius</i>	21W	25W
<i>Elgar Plus</i>	34W	40W
<i>Verdi & La Scala</i>	25W	50W

Table 7 – Power consumption for consumer products

Size and Weight

	Length	Depth	Height	Weight
<i>Purcell & Verona</i>	461mm (18.15")	413mm (16.18")	69mm (2.70")	8.5kg (18.7lbs)
<i>Delius</i>	461mm (18.15")	413mm (16.18")*	69mm (2.70")	8.8kg (19.4lbs)
<i>Elgar Plus</i>	461mm (18.15")	406mm (16.0")	75mm (2.94")	12.0kg (26.4lbs)
<i>Verdi & La Scala</i>	461mm (18.15")	415mm (16.34")**	137mm (5.39")	17kg (37.4lbs)

Table 8 – Size and weight for consumer products

- **Delius* only: the control knob protrudes out of the front by 20mm (0.79").
- ***Verdi & La Scala* only: the control knob protrudes out of the front by 13mm (0.51").
- Allow extra depth for cable connectors.

Operating Conditions

- Ambient temperature range: 0°C (32°F) to 50°C (122°F), non-condensing.
- Do not install the unit near heat sources such as radiators, air ducts, power amplifiers or direct strong sunlight.
- If in doubt, the easy test is - *Delius* is happy to work anywhere a human is.

GENERAL TECHNICAL INFORMATION

IEEE 1394 Overview

The IEEE 1394 interface is a high speed multi-channel system. It has the capacity to carry over 50 channels of DSD (Direct Stream Digital) or over 30 channels of 24 bit / 192kS/s audio data through a single cable.

From October 2001 onwards, a pair of 6-way electrical IEEE 1394 interfaces running at 200Mbit/s are available on the following *dCS* products:

- *dCS Elgar Plus* DAC, standard fit with software version 4.10 or later.
- *dCS Delius* DAC, optional fit with software version 2.10 or later.
- *dCS Purcell* Upsampler, optional fit with software version 2.11 or later.
- *dCS Verdi* SACD/CD Transport, standard fit.
- *dCS Verdi La Scala* Upsampling SACD/CD Transport, standard fit.

In the current implementation, *Purcell* can upsample standard digital formats (such as CD at 44.1kS/s 16 bits) to DSD at 2.822MS/s and output a stereo pair of DSD data onto its 1394 interface. *Verdi* can read DSD data from an SACD and output a stereo pair of DSD data onto its 1394 interface. The data is encrypted to conform to the conditions of the DSD licensing arrangements. Either *Elgar Plus* or *Delius* will accept DSD data from the 1394 interface and convert it to high quality analogue.

The hardware interface is very flexible and software configurable. We will add other features and data formats at a later date, adopting industry standard formats as they stabilise.

Synchronising IEEE 1394 interfaces

The IEEE 1394 system is great for carrying large amounts of digital audio data – but is inherently very jittery. To ensure low-jitter conversion to analogue, each unit linked by the 1394 system must be synchronised to the others by another connection.

- A DAC in slave mode should be sync'ed to *Verdi* by connecting *Verdi*'s **WCik Out** to the DAC's **WCik In**.
- A DAC in master mode should sync *Verdi* by connecting the DAC's **WCik Out** to *Verdi*'s **WCik In**.
- An Upsampler should be slaved to *Verdi*, usually by the selected PCM input (**AES** or **RCA**).

Automatic Input Selection

From October 2002 onwards, the software on the following products has been enhanced to automatically select the interface carrying data from *Verdi*:

- *dCS Elgar Plus* DAC, standard fit with software version 4.20 or later.
- *dCS Delius* DAC, optional fit with software version 2.20 or later.
- *dCS Verdi* SACD/CD Transport, standard fit with software version 1.20 or later.
- *dCS Verdi La Scala* Upsampling SACD/CD Transport, standard fit, with the **Easy Play** menu set to **Verdi**.

The system relies on a 1394 link between *Verdi* and the DAC. The DAC will automatically change inputs whenever *Verdi* changes layer or starts playing.

If the *Verdi* starts playing an SACD, the DAC selects that 1394 channel.

If the *Verdi* starts playing a CD and:

- there is a second source on the 1394 bus (such as a *Purcell*), the DAC will select the other source.
- there are more than two other sources on the 1394 bus (such as a *Purcell* or another *Verdi*), the DAC will select one of the other sources. You may have to manually select the source you want.
- *Verdi* is the only source on the 1394 bus, the DAC will scan the PCM inputs and select the first active one it finds. The priority order is: **AES1** (and **Dual AES**) first, **AES2**, **RCA1**, **RCA2**, **TOS**, **ST**, **BNC**. If the active input is not derived from *Verdi*, you may have to manually select the source you want. If none of the PCM inputs are active, the DAC will remain selected to the original 1394 channel.

This arrangement works best with only two inputs connected to the DAC – *Verdi*'s 1394 feed for SACD's and either a PCM feed from *Verdi* or an upsampled feed from *Verdi*. The DAC can be in master or slave mode – we recommend master mode.

If you are using a *Purcell* in Dual AES mode (rather than DSD mode), you should set the DAC's **Dual AES** menu page to either **Lock** or **Auto**.

The DAC has enough information about the system set-up to report connection and setting errors. These are:

- **Verdi Wordclock Missing**
- **Please Check Source Slaved to Delius / Elgar Plus Wordclock Out**
- **Missing Wordclock between ClkOut and Verdi Clk In**
- **Wrong Fs @ Verdi Clk In**

dCS IR Remote Control Codes

This section gives details of the Remote Control codes generated by dCS IR Remote Control units, for use with programmable remote controls. All dCS Remote Control units use the RC5 system and a carrier frequency of 37.9kHz. For more information on the use of dCS Remote Control units, please refer to the manual for that unit.

IMPORTANT!

Please note that dCS cannot accept responsibility for any difficulties experienced with other manufacturer's remote control units.

Upsampler

For *Purcell*, the category code is **29** (decimal).

These Upsampler codes are in use on the *Elgar Plus / Delius* Remote v2.0 and Transport Remote v2.0.

Button Code		<i>Purcell</i>
Decimal	Hexadecimal	RC button
1	01	RCA1 / RCA2
3	03	AES1 / AES2
6	06	BNC
7	07	Display
12	0C	Standby
14	0E	Filter
16	10	(up)
17	11	(down)
26	1A	Function
27	1B	Input
32	20	32kS/s out
33	21	44.1kS/s out
34	22	48kS/s out
35	23	88.2kS/s out
36	24	96kS/s out
37	25	176.4kS/s out
38	26	192kS/s out
39	27	DSD/1394 out
41	29	Standby ON
42	2A	Standby OFF
43	2B	Power OFF
44	2C	Filter 1
45	2D	Filter 2
46	2E	Filter 3
47	2F	Filter 4

DACs

For all DACs, the category code is **13** (decimal).

These DAC codes up to decimal 27 are in use on the *Elgar Plus / Delius* Remote v2.0, Transport Remote v2.0 and *Elgar* Remote v1.0. *Elgar Plus* v4.20 or later and *Delius* v2.20 or later will respond to codes over decimal 27.

Button or Function Code		<i>Elgar Plus / Delius</i>	<i>Elgar</i>
Decimal	Hexadecimal	RC function	RC button
1	01	RCA1	Coax1
2	02	-	Opt2
3	03	AES1	AES1
4	04	AES2	AES2
5	05	-	Opt1
6	06	BNC	Coax2
7	07	Display	Display
8	08	Vol/Bal	Vol/Bal
9	09	Phase	Phase
12	0C	Standby	Standby
13	0D	Mute	Mute
14	0E	Filter	Filter
15	0F	RCA2	-
16	10	(up)	(up)
17	11	(down)	(down)
26	1A	Function	-
27	1B	Input	Input
32	20	Dual AES	-
33	21	SDIF	-
34	22	1394 CH 0	-
35	23	1394 CH 1	-
36	24	1394 CH 2	-
37	25	1394 CH 3	-
38	26	1394 CH 4	-
39	27	Mute On	-
40	28	Mute Off	-
41	29	Standby On	-
42	2A	Standby Off	-
43	2B	Power Off	-
44	2C	Filter 1	-
45	2D	Filter 2	-
46	2E	Filter 3	-
47	2F	Filter 4	-
48	30	Filter 5	-
49	31	Filter 6	-
50	32	Master	-
51	33	Slave	-

Transports

For *Verdi & La Scala*, the category code is **20** (decimal).

These Transport codes are in use on the Transport Remote v2.0.

Button Code		<i>Verdi</i>
Decimal	Hexadecimal	RC button
0	00	Keypad 0/10
1	01	Keypad 1
2	02	Keypad 2
3	03	Keypad 3
4	04	Keypad 4
5	05	Keypad 5
6	06	Keypad 6
7	07	Keypad 7
8	08	Keypad 8
9	09	Keypad 9
10	0A	Standby ON
11	0B	Standby OFF
12	0C	Standby (toggle)
15	0F	Display
25	19	Stop Rewind
26	1A	Stop Fast Forward
29	1D	Repeat
32	20	Next Track
33	21	Previous Track
34	22	Next Index
35	23	Previous Index
36	24	Play Mode
41	29	Program
43	2B	Fast Forward
50	32	Rewind
53	35	Play
54	36	Stop/Eject
55	37	Power OFF ⁶
58	3A	Clear
59	3B	A/B
60	3C	SACD/CD
61	3D	Select CD layer
62	3E	Select SACD layer

⁶ The Power Off code was 63 decimal in *Verdi* v1.20 – 1.25. Some Pronto units were found to send code 20-63 for no apparent reason, so we changed the code to 55 decimal.

USING YOUR *dCS DELIUS* FOR THE FIRST TIME

Thank you for purchasing this *dCS Delius*. Before attempting to use your *Delius*, please read at least the rest of this section and the “Step-by-Step Guide” on page **10**. This will enable you to set the unit up quickly with your hi-fi system.

What’s in the Box?

The box should contain the following:

- *dCS Delius*
- User Manual
- Control Summary
- Power Cable
- Spare Fuses (2)

Units supplied with a Remote Control⁷ should also be supplied with the following:

- Remote Control unit
- 3 x AAA batteries
- Pozidriv screwdriver (1 pt)

For safety reasons, the Remote Control is shipped with the batteries packed separately. For fitting details, see the “Maintenance and Support” section, starting on page **60**.

Units fitted with an IEEE 1394 interface⁸ should also be supplied with the following:

- IEEE 1394 cable assembly
- BNC cable

Check the contents of the inner carton very carefully against the list above. Notify your dealer as soon as possible if anything is missing or damaged. *dCS* suggest that all of the original packaging is retained for use when transporting any units. Replacement packaging can be ordered from *dCS* or our distributors.

Safety Notice

Delius contains no user serviceable parts. Do not attempt to open the case as there are potentially dangerous voltages present inside. In the event of the unit developing a fault, please consult your dealer.

IMPORTANT!

This equipment MUST be connected to a safety earth (or ground) via the power cable.

⁷ The Remote Control is an optional extra with *Purcell* units and is not supplied with *Verona*.

⁸ The IEEE 1394 interface is an optional extra with *Purcell* or *Delius* units and is not yet available with *Verona*.

Mains Voltage Setting

Before connecting the power cable to your *Delius* for the first time, please check that it has been set to the correct operating voltage for your local mains supply. 50Hz or 60Hz operation is not important – the unit can use either. The unit's present voltage setting is shown on the label beneath the mains inlet on the rear panel. If this does not match your local supply voltage, DO NOT attempt to use the unit. Contact your dealer to arrange to have the unit reset. Using the *Delius* with the wrong mains setting for your local supply may result in serious damage to the unit and will invalidate the warranty. DO NOT attempt to reset the unit yourself.

IMPORTANT!

Please use a sensible power cable, such as the one supplied with the unit. Some audiophile power cables presently available are excessively heavy, their weight can damage the power inlet connector. Such damage is not covered by the warranty.

Positioning the Unit

Place *Delius* on a firm, vibration free base so as to allow convenient connection to your digital source. We suggest that you avoid siting *Delius* either directly above or below preamplifiers or tuners, if either of these will be used in your system at the same time as *Delius*.

OPTIONS

The following options may be fitted to new units or retrofitted at a later date.

Option code	Option
1394	IEEE 1394 interface
V5	Mains voltage set to 230/240V
V4	Mains voltage set to 215/220V
V3	Mains voltage set to 200V
V2	Mains voltage set to 115/120V
V1	Mains voltage set to 100V

Table 9 – Options available

IEEE 1394 Interface

We can fit an IEEE 1394 interface to enable the unit to generate / receive DSD data on either of two 6-way connectors. The cost of this option depends on the age of your unit. Note the full serial number of your unit and contact your *dCS* distributor for advice. This option must be fitted at *dCS* to allow full checking. See the “Rear Panel” section on page 39 and “IEEE 1394 Overview” on page 50.

Mains Supply Voltage

Any unit may be set for operation from 230/240V, 215/220V, 200V, 115/120V or 100V A.C. Units are shipped set for the mains supply voltage according to the destination. The voltage setting can be updated later by your dealer, if necessary. Specify the new country of use or the new voltage setting.

Having Your Options Changed

dCS support modifications, updates and option changes to supplied units. Major changes are normally carried out at *dCS* as we have extensive test facilities and can verify the changes. Please contact your dealer / distributor or *dCS* for details.

IMPORTANT!

Please do not attempt the changes yourself. The unit's performance or reliability may be impaired and the warranty will be invalidated.

MAINTENANCE AND SUPPORT

Service & Maintenance

dCS audio products are designed not to need regular maintenance, and contain no user serviceable parts apart from the mains fuse.

Obtaining Service

If you experience problems with your *Delius*, you should check the “Troubleshooting” section on page 64. You may be able to resolve the situation yourself (for example, by changing a menu setting).

If this does not resolve the problem, contact your authorised dCS dealer for advice, quoting the model, the full serial number (see *Serial* on page 32), the software version number (see *Issue* on page 32) and giving a detailed description of the fault. If further action is necessary, your dealer will advise you fully.

Mains Fuse

There is a mains fuse below the power inlet, accessible from the outside of the unit. If the fuse blows, it may be changed by the user. The current consumption of the unit is very low, so it only blows if power surges occur, or there is a fault in the unit. Usually, power surges cause no other damage, but if the fuse blows repeatedly on replacement, some other damage will have been done and the unit must be returned to dCS for repair.

Fuse Type: 20 x 5mm 0.5 amp T HRC fuse

IMPORTANT!

If the fuse should fail, it is essential that it be replaced with one of the same type and rating. Failure to do so could result in damage to the unit, risk of fire or electric shock and will invalidate the guarantee.

Replacing a Blown Fuse

Referring to **Figure 11**, remove the power cable, use a small flat bladed screwdriver to pry up the tab on the fuse carrier (A) and pull it out. Push the blown fuse out of the clip in the carrier (B) and dispose of it. Fit a new fuse in the clip (C) and push the carrier back into the unit so that it clicks home. Spare fuses are provided with the unit.

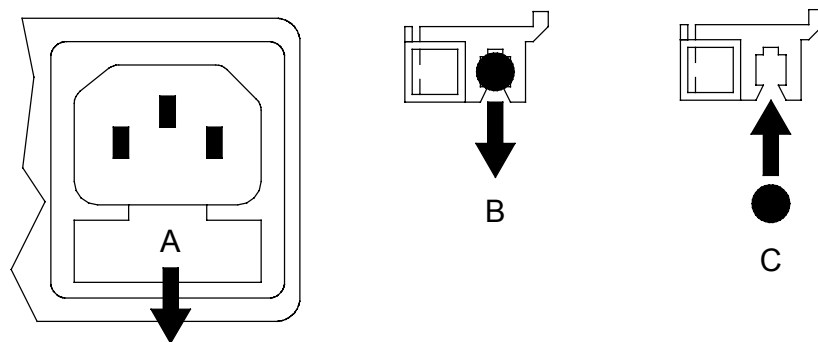

Figure 11 – Changing the Mains Fuse

IMPORTANT!

Disconnect the power cable before changing the fuse.

Fitting or Replacing the Batteries in the Remote Control

For safety reasons, the Remote Control is supplied with the 3 batteries packed separately. Any replacement batteries must be type AAA, MN2400 or equivalent alkaline leak-proof batteries.

Opening the battery compartment and removing batteries

do this: Turn the Remote Control unit over and remove the 4 screws shown in **Figure 12** using the 1-point Pozidriv screwdriver supplied. Please do not use a Philips head screwdriver as this will damage the screw heads. Lift off the battery cover.

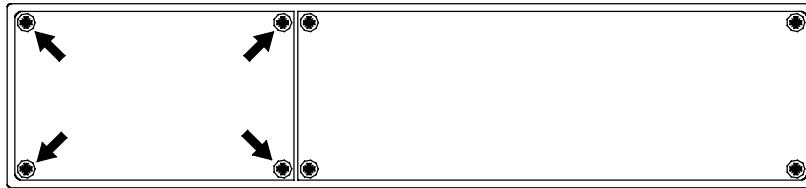

Figure 12 – Removing the Remote Control battery cover

do this: To remove discharged batteries, press the + end back against the spring and pull that end out of the unit. A small key or screwdriver may be used if the battery is a tight fit. Dispose of the discharged batteries safely.

Fitting new batteries and closing the case

do this: To fit a new battery, press the - end (the flat end) against one of the spring contacts in the battery holder then press the battery into its slot. Battery polarity is indicated on the battery holder and on the diagram below. Always fit a complete set of 3 new batteries.

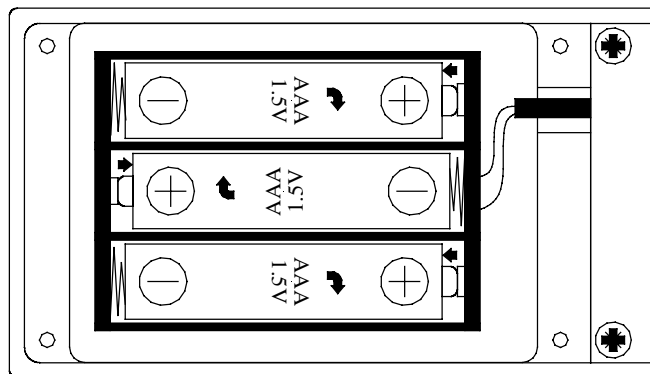

Figure 13 – Changing the Remote Control unit batteries

IMPORTANT!

Please ensure the batteries are fitted the right way around – failure to do so may damage the Remote Control and invalidate the warranty. Damage caused by leaking batteries is not covered by the warranty.

do this: To re-assemble the case, fit the battery cover, ensuring the side with the recessed holes is outward. Replace the 4 screws, taking care not to over-tighten them. The Remote Control is ready for use.

Updating your *Delius*

dCS products make extensive use of software configurable chips – FPGAs and DSPs. This gives us the ability to update our products to add extra features, update digital interface standards or make performance improvements by loading new software. Occasionally, a hardware update may be necessary also to increase the “capacity” of the electronics, add extra connectors or extra front panel controls.

Software Updates

Please note that not all software updates make an earth-shattering change. You should have a clear idea of what you expect to gain before updating to the latest issue.

If the software loaded in your unit is (for example) version 3.45:

- A change to version 3.46 indicates a minor update for internal *dCS* use – to make testing easier, or more thorough, or to cater for some minor hardware change. Do not update your unit.
- A change to version 3.50 is a more serious update, offering extra functionality. If you want to use the extra features, update your unit. The manual will be updated for this (check the web-site).
- A change to version 4.00 is a major update. It will require updated hardware and the manual will be updated

If you have older hardware, some of the features added by new software may not be available due to (for example) a missing connector. For **recent** hardware, this is mentioned in the “Upgrader’s notes” in this manual. If you need the missing feature, contact your dealer or *dCS* to arrange a hardware update.

- If the software currently loaded includes a **CD Update** page, you can update the software yourself. Contact *dCS* for a CD and follow the instructions in the **CD Update** section on page **33**, or the instructions supplied with the CD. The update program will check your hardware configuration and install the latest software compatible with it.
- If you do not have the **CD Update** feature loaded or have difficulty with it, a *dCS* distributor can download files from a PC into any unit fitted with a **SUC** connector. Contact your dealer for details.
- For older units without a **SUC** connector, your distributor can install new firmware in your unit. Firmware updates are low-cost from *dCS*. Contact your dealer for details.

Hardware Updates

You may wish to have your hardware updated from time to time to take advantage of new features in the latest software. *dCS* offer this service - we will retest, reset any adjustable items to current shipping standards, and install any modifications or updates that have occurred since your unit was first shipped.

The price will depend on the hardware changes necessary – please contact your dealer or *dCS* for details and pricing. In order to ensure speedy turn around, please contact us prior to returning the unit to get a **Service Return** number.

Safety and Electrical Safety

There are no user serviceable parts inside *Delius* and so there is no need to remove the covers. If for some reason you do:

IMPORTANT! *Disconnect the power cable before removing any covers or changing the fuse.*

There are no substances hazardous to health inside *Delius*.

Cleaning the Case

Do not apply any of the following cleaning products to the case as they will damage or alter the finish:

- Corrosive or abrasive agents
- Spirit or alcohol based cleaners
- Wax polish

do this: To remove dust, wipe with a moist, soft cloth.

do this: To remove deposits from the case, first disconnect the power cable then spray very lightly with a proprietary glass cleaner containing ammonia and wipe off gently with a soft cloth, taking care to avoid scratches. Do not spray the cleaner onto the connectors or the rear panel.

TROUBLESHOOTING

Fault Indication

Delius detects the following fault conditions:

Power interruption

If the AC supply is momentarily interrupted or is more than 20% below its rated voltage, the unit displays **PowerDn** and mutes the audio outputs to protect your loudspeakers from damage. This may be caused by loose AC power wiring, local power-line overloads or heavy-duty appliances like air conditioners. If this message appears frequently (other than when switching the unit off), please consult your dealer.

Power up test errors

If *Delius* detects a fault during its power up test routine, it will remain muted and display one of these messages:

- **DSPs Not Loaded (#01)**
- **FPGAs Not loaded (#02)**
- **Bad Checksum. Press any key to attempt recovery (#03)**
- **DSP-Err1 (#04)**

This can be caused by power line transients occurring during system configuration. For **Bad Checksum**, press any button to try to clear the fault. Otherwise, try switching off, waiting 20 seconds, then switching on again. If the fault persists, please consult your dealer.

Non-Audio disk

Playing a Non-Audio CD (e.g. CD-I, CD-R, Photo CD, etc.) causes *Delius* to remain muted and display **Nonaudio**.

If you are **SURE** the disk is playable audio, *Delius* can be set to ignore this flag. The Non-Audio flag may have been incorrectly set on the CD. See **NAud** on page **29**.

IMPORTANT!

The Non-Audio Muting feature protects your ears and equipment from damage. Think carefully before turning it off.

The unit is overheating

If the internal temperature sensor detects a high running temperature (over 70°C or 158°F), the unit displays **Too Hot!**.

If this occurs, there is insufficient ventilation, causing the unit to overheat. Switch off and allow the unit to cool for 10 minutes. Check that air flow around the unit is not restricted and that it is not located above a power amplifier or other source of heat. Continuous operation at these high temperatures may result in permanent damage and will invalidate the warranty. See "Operating Conditions" on page **49**.

Troubleshooting Guide

If you experience difficulties when using *Delius*, the following suggestions may help resolve the problem.

The unit fails to power up

- Ensure there is power available on the mains cable. Connect the power cable, wait 10 seconds then press the **Power/Standby** button.
- Check the rated supply voltage shown on the rear of the unit matches the local supply voltage.
- Check that the fuse has not blown - if so, correct any obvious cause then replace the fuse as described on page **60**.

The unit fails to lock to a digital audio source or displays “No Input”

- Ensure the correct input is selected (see page **36**).
- Check that the digital audio cable is of the correct type, correctly connected and not damaged. Try another cable. Damaged cables are a VERY common cause of malfunctions!
- Check that the source is switched on.
- Some CD players do not generate a digital output unless the disc is playing - set the player in “play” mode and check that the unit locks.
- Occasionally, we find a CD player whose sample rate is outside the standard +/-300ppm tolerance specified for CD players. If *Delius* locks to another source but not to your CD player, the player may need servicing.
- If you are using Master mode or a Master Clock, try slaving to the audio input. If the unit locks, check the Wordclock connections.

The unit locks but the audio output is low or absent

- Check that the **MUTE** indicator is off. If not, press the **Mute** button.
- Check that the audio output cables are correctly connected, the equipment following *Delius* is switched on and correctly set up.
- Ensure the **Volume** and **Balance** controls are correctly set (see **Rotary Control** on page **38** and **Bal Mode** on page **28**)
- Ensure the source is sending audio data (see **NAud** on page **29**).
- Ensure the **Output Level** is correctly set - turn the **Volume** control down by 10dB before changing this setting.

The output is monophonic

- The source is Dual AES but *Delius* is set to Single AES (**AES1** or **AES2** indicator lit) – see page **25**.
- If both **AES1** & **AES2** indicators are flashing, the unit is set to **Dual AES – Lock** but one AES cable is either disconnected or faulty (see page **25**)
- The source disk / tape may actually be monophonic.

The unit fails to respond to the controls

- Check that the **STBY** indicator is not lit - if so press the **Power/Standby** button to return to normal operation. Alternatively, switch off, wait 10 seconds and switch on – Standby mode will be cancelled.
- While locking to a source or changing some settings (e.g. Filter), the microcontroller inside *Delius* is busy and will not respond to new commands for a few seconds.
- If the Mute fade-out rate is set to **Mute-Slw**, the unit may be unresponsive for a few seconds while slow muting is in progress (see page **24**)
- Short mains supply drop-outs may cause the microcontroller to lock up. Switch off the unit, wait 10 seconds then switch on again. If this does not clear the fault, please contact your dealer.

The Main Display turns on briefly when a control is operated, then turns off

- This happens when the **Display Brightness** is set to **Bright 0**. Change to any other brightness setting to stop the display blanking out (see page **26**).

The Left and Right channels are swapped

- Check that the audio output cables are not reversed.
- Open the menu and page through until the **Swap** page is displayed. If it is set to **Swap-On**, change it to **Swap-Off**.
- Check that the channels are not swapped elsewhere in the system.
- If you are using **Dual AES** mode, ensure that **AES 1** input is connected to the output on the source equipment carrying the Left channel data (probably labelled AES1 or AES A) and the **AES 2** input is connected to the output on the source equipment carrying the Right channel data (probably labelled AES2 or AES B). See the manual for the source equipment for information, and also page **25**.

One audio output channel is low or absent

- Check that the **Balance** control is correctly set (see **Rotary Control** on page **38**).
- Check that the audio output cables are connected correctly and are not damaged.
- Check that the balance is not offset elsewhere in the system.

The sound has a peculiar tonal balance

- Set De-Emphasis to **Auto** – see page **27**.
- If this fails to correct the problem, the De-Emphasis flags in the data stream may be incorrectly set (this is rare but it does happen). To find the correct De-Emphasis characteristic, change the De-Emphasis setting to **50/15µs**, **CCITT** or **Off** in turn until the correct setting is found. When you change to a different disk or tape, we recommend setting **De-Emph** to **Auto** again.

Crackles or pops occur while playing music

- The source may have a high level of jitter. Try setting the **PLL** parameter to **PLL:Wide**. See page **29**.
- The digital audio cable connecting *Delius* to the source may be damaged, intermittent or of the wrong type. Some expensive cables are not correctly designed for digital audio use. Try another cable.
- The CD may be dirty - clean it very carefully using a radial motion.
- The disk / tape may be damaged or contain corrupted data.
- The audio output level may be enough to overload a preamplifier or power amplifier.

Erratic operation when locked to 96 or 88.2kS/s on **Toslink** or **ST** inputs

- Check your optical connections are clean and properly installed.
- The Toslink and ST receiver devices are industry standard types which are not guaranteed to operate correctly at 96 or 88.2kS/s. Connect to a different input instead.

The unit will not decode **Dual AES**

- Dual AES mode may be disabled. Open the menu and set the **Dual AES** page to **On** (see page **25**). Connect a valid 88.2, 96, 176.4 or 192kS/s Dual AES source to both **AES 1** and **AES 2** inputs. Press the **Input** selector button repeatedly until both **AES1** and **AES2** indicators are lit.
- Your source equipment may have two AES outputs but might not be capable of Dual AES operation. Check the manual for the source equipment.

The unit drops out of **Dual AES** mode into **AES1** or **AES2**

- Dual AES mode is only available if AES data streams are available on both **AES 1** and **AES 2** inputs. If either of these are interrupted or become corrupted while in **Dual AES** mode, the unit may default to single AES mode and select the valid input. Check for faulty wiring to the input which has been deselected. Once both data streams are stable again, **Dual AES** mode may be selected using the **Input** button or the Remote Control. See page **25**.
- If you are driving *Delius* direct from an Upsampler always set to output Dual AES, you may find that changing inputs on the Upsampler causes *Delius* to fall out of **Dual AES** mode. To prevent this, *Delius* may be locked in **Dual AES** mode. Open the menu and page through until you reach the **Dual AES** page. Change the setting to **Lock**. Select **AES 1** or **AES 2** input on *Delius* and it will enter **Dual AES** mode automatically (see page **25**).

A digital recorder fails to record from the **REC** Output

- If *Delius* is selected to an SPDIF input (**RCA**, **BNC**, **ST** or **TOSLINK**) and the source data (CD for example) is copy protected, your recorder will be prevented from recording the data. This prevents copyright infringement. Note that AES data streams have no Copy Prohibit flag.
- In some DAT machines, the digital input is connected directly to a digital output without buffering. This arrangement does not comply with the IEC60958 standard. Connecting another device to this may overload *Delius*' **REC** output and corrupt the digital data.
- The **REC** output is usable with single **AES**, **RCA**, **BNC**, **Toslink** or **ST** inputs ONLY.

The Remote Control fails to control the unit

- The Remote Control is normally shipped with the batteries packed separately for safety reasons. If you are using the Remote Control for the first time, you must fit the batteries first – see page 61.
- If the Remote Control has not been used for a long time or has gradually lost range, the batteries should be replaced - see page 61.
- If you have just replaced the batteries but the unit still does not work, check that the batteries are fitted the right way around - see page 61. If two or more batteries were fitted the wrong around, the Remote Control may be permanently damaged. If this occurs, contact your dealer for advice.
- For correct operation, there must be a clear line of sight between the infrared transmitter at the end of the Remote Control and the infrared receiver in *Delius*, located on the left hand side of the display. If the line of sight is blocked (for example by a coffee table) the Remote Control may operate erratically or not at all.
- While the unit is displaying **Locking** or **Wait ...**, the system timing is fluctuating and this may temporarily disrupt the operation of the Remote Control. Once the unit locks, normal operation will be resumed.

While playing a DVD, a burst of noise is heard, *Delius* mutes and changes sample rate

- We have found that some DVDs have been compiled with tracks recorded at different sample rates (e.g. 96kS/s & 48kS/s). There is no warning of this sudden change in sample rate (this could be done by using the Non-Audio flag or by changing the sample rate code in the data stream), so the DAC tries to decode corrupted data momentarily before registering loss of sync, muting and re-locking. The root cause of the problem is a lack of a formal interface standard covering sample rates above 48kS/s. When a new standard is agreed, *Delius*' software can be updated to comply with it. This is unlikely to improve the situation with existing disks. Meanwhile, we suggest you reduce the volume at the end of the track where a change occurs and increase it when *Delius* displays a new sample rate.

CD Update is interrupted or fails

- If a software update from a dCS CD is interrupted, the **original** software may be recovered by switching *Delius* off and on, then waiting a few minutes. See **CD Update** on page 33.
- If you are using an Upsampler or other device, ensure it is set to bit-for-bit (**Clone**) mode.
- If your CD player upsamples to 48kS/s or 88.2kS/s or adds dither (a few types do this), the update program will reject the data. Use or borrow an "ordinary" CD player.

CD Update is interrupted and fails to recover

- It is just possible (but very unlikely) that the recovery will fail if the recovery code was being over-written when the interruption occurred. If you are very unlucky and this happens, ask your dealer for help. New software must be loaded from an EPROM.

Troubleshooting the IEEE 1394 Interface

This section covers difficulties that may be encountered using a *dCS Verdi* SACD Transport (v1.20 or later), a *dCS Verdi La Scala* Upsampling SACD Transport or a *dCS Purcell* Upsampler to drive a *dCS Elgar Plus* DAC (v4.20 or later) or *Delius* DAC (v2.20 or later) with DSD data over an IEEE 1394 interface.

Upsampler or Transport displays “Inactive”

- This can happen momentarily during locking. If it does not change to **Active**, open the Transport or Upsampler’s menu and ensure the **Transmit** page is set to **Active**.

The Unit keeps displaying “No Comms”

- This will appear briefly while the 1394 system is checking for connections.
- If the **No Comms** message does not clear, ensure that all units in the 1394 chain are switched on and securely connected by 1394 cables.

The Unit keeps displaying “Search..”

- This will appear briefly after the 1394 system has established communications.
- If the **Search** message does not clear, ensure that you have not connected both 1394 connectors from one unit to both 1394 connectors on another unit or set up a loop. This prevents the 1394 bus settling.
- Check that the 1394 cables are correctly fitted.

The DAC displays “Verdi Wordclock Missing”

- With the DAC in slave mode, check there is an undamaged BNC cable connecting *Verdi*’s **WCik Out** to the DAC’s **WCik In**.
- Ensure the cable is D.C. coupled. A.C. coupled cables are not suitable for use with Wordclock or SDIF.

The DAC displays “Missing Wordclock between Clik Out & Verdi Clik In”

- With the DAC in master mode, check there is an undamaged BNC cable connecting the DAC’s **WCik Out** to *Verdi*’s **WCik In**.
- Ensure the cable is D.C. coupled. A.C. coupled cables are not suitable for use with Wordclock or SDIF.

The DAC displays “Please check source slaved to DAC Wordclock Out”

- With the DAC in master mode, check there is an undamaged BNC cable connecting the DAC’s **WCik Out** to the source’s **WCik In**.
- Ensure the cable is D.C. coupled. A.C. coupled cables are not suitable for use with Wordclock or SDIF.

The DAC displays “Wrong Wordclock @ Verdi Clik In”

- *Verdi / La Scala* has detected a clock frequency other than 44.1kHz on it’s **WCik In** connector. Ensure the clock source is set to 44.1kHz.
- With the DAC in master mode, check there is an undamaged BNC cable connecting *Verdi / La Scala*’s **WCik Out** to the DAC’s **WCik In**.
- Ensure the cable is D.C. coupled. A.C. coupled cables are not suitable for use with Wordclock or SDIF.

The DAC remains muted

- If the DAC is displaying the **Volume** setting, change the **Disp** menu page setting to **Disp:Fs** and check for error messages.
- If all else is in order, switch off the Transport, the Upsampler and the DAC then switch them on again. If this situation keeps recurring, please consult your dealer.

The DAC takes a long time to unmute

- The **1394** interface can take around 30 seconds to settle and unmute.
- Try setting the DAC to **1394** mode before setting the Upsampler to **DSD** mode.
- If your system is in standby mode or switched off, try turning the DAC on before the Upsampler or Transport.

If this information does not resolve the problem, please contact your dealer for advice.

IF YOU NEED MORE HELP

In the first instance, you should contact your dealer. If they cannot resolve the issue, contact *dCS*. Our office hours are 8:30 a.m. to 5:00 p.m. Monday to Friday, UK time (GMT in Winter or GMT + 1hr in Summer). Contact us by phone or fax on:

	Inside the UK	Outside the UK
Telephone	01799 531 999	+44 1799 531 999
Fax	01799 531 681	+44 1799 531 681

Table 10 – *dCS* Contact Information

You can write to us at:

dCS Ltd
Mull House
Great Chesterford Court
Great Chesterford
Saffron Walden CB10 1PF
UK

Our email address: more@dcsLtd.co.uk

Our web-site is: www.dcsLtd.co.uk

The web-site is regularly updated. You will find full details of all *dCS* products here, plus the latest *dCS* news.

Other Information

dCS produce technical notes from time to time, on issues related to ADCs, DACs and DDCs. If you are interested in these, please check our web-site.

INDEXES AND SOFTWARE VERSION NUMBERS

Software History

This manual is for *Delius* software version 2.3x.

Version 2.3x differs from 2.2x versions as follows:

In PCM mode, *Delius* can now lock to an external word clock that is at an exact multiple of the sample rate. For example:

- with a data rate of 96kS/s, the word clock may be at 32, 48 or 96kHz (previously 96kHz only).
- with Dual AES data at 176.4kS/s, the word clock may be at 44.1 or 88.2kHz (previously 88.2kHz only).
- with Dual AES data at 192kS/s, the word clock may be at 32, 48 or 96kHz (previously 96kHz only).

Note that DSD mode still requires a 44.1kHz word clock only.

Version 2.2x differs from 2.1x versions as follows:

- (Units with 1394 option only) *Delius* responds to status messages sent over the 1394 interface from a *Verdi* (v1.2x) to allow automatic switching between SACD and CD modes. This also allows *Delius* to report any cabling faults.
- **1394 Src** menu deleted – 1394 sources are selected with the **Input** button or automatically selected by a *Verdi*.
- **Clock** menu deleted. In Master mode, *Delius* outputs a Wordclock at 44.1kHz only. **Wordclock Out** is disabled in **Slave** or **Sync** modes.
- **Part No.** menu deleted.
- After a **Factory** reset, the inputs are set up to match the other *dCS* units in the system.
- 1394 operation generally improved, system messages changed.

Version 2.1x differs from 2.0x versions as follows:

- menu order rearranged.
- improved IEEE **1394** interface behaviour.
- **Reset Sync** menu added.

Version 2.0x differs from 1.1x versions in supporting DSD at 2.822MS/s over the optional IEEE **1394** interface.

(Upgrader's note: the **1394** interface hardware may be retrofitted to any unit.)

Version 1.13 differs from version 1.11 in supporting synchronisation to the **Wordclock** Input.

(Upgrader's note: on units manufactured before February 2001, the **Wordclock** Input was labelled **OPTION** or was blanked off.)

Version 1.11 differs from version 1.0x as follows:

- in supporting Master Mode clock operation (it can give out a clock for CD players, for example, to lock to),
- in supporting updates of the software by CD,
- and in offering more filters (6 instead of 4 at 176.4 kS/s and 192 kS/s)
- in allowing partial resets.

Definitions and Abbreviations

ADC	Analogue to Digital Converter, sometimes referred to as an A/D Converter.
AES3	A standard professional stereo digital audio format consisting of one serial PCM data line. It uses a balanced cable to extend transmission distance and includes a comprehensive messaging system.
DAC	Digital to Analogue Converter, sometimes referred to as a D/A Converter.
dB	A relative signal level or ratio in decibels. The context may indicate the reference level.
dB0	Level in decibels, referred to a full scale sine wave in a sampled system. So, 0dB0 is full scale.
dBu	A signal level relative to 0.775V rms, making no allowance for external loading.
DDC	Digital to Digital Converter, sometimes referred to as a D/D Converter.
DSD	Direct Stream Digital - a single bit digital audio format, sampled at 2.822MS/s.
kS/s	Sample rate in kilo-samples per second. This replaces kHz, which is technically incorrect when referring to sample rates.
SDIF-2	Sony Digital InterFace – a stereo digital audio format consisting of 2 serial PCM or DSD data lines. Usually used with a Word Clock.
SPDIF	Sony / Philips Digital InterFace – a stereo digital audio format for consumer equipment, consisting of one serial PCM data line. Similar to AES3, but unbalanced and with different messaging.
Word Clock	A synchronisation signal consisting of a square-wave, the frequency of which is the sample rate. Usually transmitted through co-axial cable and BNC connectors.

Key to Cable Identification

If you are reading a colour print or a soft copy of this manual, cable types shown in figures can be identified from **Table 11**.











Cable Type	Colour / Style	
XLR Analogue	Brown, solid	
RCA Phono Analogue	Brown, long dash	
XLR Digital (AES3)	Blue, solid	
BNC Digital	Pale blue, solid	
RCA Phono Digital (SPDIF)	Pale blue, short dash	
Optical (SPDIF)	Dark magenta, solid	
IEEE 1394	Red, solid	
Sync Link	Green, solid	
Wordclock	Dark green, solid	
AES Reference	Dark green, long dash	
GPS Reference	Dark green, short dash	
RS-232	Purple, solid	

Table 11 – Cable colours and styles

Where more than one cable of any type is used in a drawing, they can be identified by a coloured sleeve at the source and a coloured arrow head at the destination.

List of Tables

Table 1 – AES/EBU Interface Electrical Characteristics	46
Table 2 – SPDIF Interface Electrical Characteristics	46
Table 3 – Optical Interface Electrical Characteristics	46
Table 4 – SDIF / Wordclock Interface Electrical Characteristics	46
Table 5 – IEEE 1394 Interface Electrical Characteristics	47
Table 6 – Analogue Output Electrical Characteristics	48
Table 7 – Power consumption for consumer products	49
Table 8 – Size and weight for consumer products	49
Table 9 – Options available	58
Table 10 – dCS Contact Information	71
Table 11 – Cable colours and styles	74

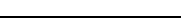
List of Figures

Figure 1 – Basic setup with a CD player	12
Figure 2 – Using Master Mode with a CD player	14
Figure 3 – Using <i>Delius</i> in Master Mode with <i>Verdi</i>	16
Figure 4 - Using <i>Delius</i> in Master Mode with <i>Verdi</i> and <i>Purcell</i>	17
Figure 5 – Using <i>Delius</i> with <i>Purcell</i> and a CD player	18
Figure 6 – Function Menu flow chart	20
Figure 7 – dCS <i>Delius</i> Front Panel	36
Figure 8 – dCS <i>Delius</i> Rear Panel	39
Figure 9 – The Remote Control	43
Figure 10 – Frequency responses at all sample rates, set to Filter 1	47
Figure 11 – Changing the Mains Fuse	60
Figure 12 – Removing the Remote Control battery cover	61
Figure 13 – Changing the Remote Control unit batteries	61

Keywords and Phrases

1	
1394 input, selecting.....	11
1394 interface.....	41, 50
1394 interface, synchronising.....	50
1394 interface, troubleshooting.....	69
1394 mode.....	72
1394 option.....	58

A

Active message.....	69
ADC.....	73
AES input, selecting.....	11
AES inputs.....	40
AES/EBU.....	40
AES3.....	73
Analogue outputs, balanced.....	39
analogue outputs, connecting to.....	12
Analogue outputs, unbalanced.....	40
anti-image filter.....	21
audio absent problem.....	65
automatic input selection.....	50, 72

B

Bad CD! message.....	33
Bad Checksum message.....	33, 64
Bal menu.....	27
Balance display mode.....	27, 38
Balance display, bars.....	27
Balance display, numbers.....	27
Balance menu.....	27
Balance setting.....	38, 48
Balance, setting from front panel.....	27
balanced or unbalanced outputs?.....	39
balanced outputs.....	39
batteries for remote control.....	61
batteries, polarity.....	61
biography, Frederick Delius.....	4
blank display.....	26, 66
blue LED, remote.....	44
BNC input.....	40
Bright x menu.....	26
<i>Burn In</i> menu.....	30
burn-in routine.....	30
button, Display, remote.....	44
button, Filter, remote.....	44
button, Function.....	38
button, Function, remote.....	43
button, Input.....	36
button, Input, remote.....	44
button, Menu Select.....	20
button, Menu Step.....	20
button, Menu Step Back.....	20
button, Mute.....	37
button, Mute, remote.....	44
button, Phase, remote.....	44

button, Power.....	36
button, Purcell, remote.....	44
button, Select.....	38
button, Standby, remote.....	43
button, Step.....	37
button, Step Back.....	37
button, Vol/Bal, remote.....	44
buttons, Up and Down, remote.....	44

C

cable identification.....	74
cables.....	10, 39, 40, 41, 65
Can't Use Frequency message.....	23
cannot record from REC out.....	67
cannot set Filter.....	44
Caution message.....	30
CD player.....	3
CD player problems.....	65
CD player, jittery.....	28
CD Update fails.....	68
<i>CD Update is interrupted</i>	33, 68
CD Update menu.....	32
CD-ROM, playing.....	28, 37
Ch.Check menu.....	29
changing option.....	58
channel check routine.....	29
channels, swapping.....	25
cleaning the case.....	63
clock cleaning.....	48
clocking.....	48
closing the Function Menu.....	20
connecting the analogue outputs.....	12
contact information.....	31, 71
Contact menu.....	31
contents of box.....	56
control, rotary.....	38
converter type.....	46
Copy Prohibit flag.....	67
crackles and pops.....	67
crystal oscillator.....	48

D

d xxx message.....	38
DAC.....	73
DAC remains muted, 1394 input.....	70
DAC takes time to unmute, 1394 input.....	70
dB.....	73
dBu.....	73
DDC.....	73
De-Emph menu.....	26
de-emphasis.....	26, 48, 66
de-emphasis Off.....	26
de-emphasis options.....	26
de-emphasis, 50/15µs.....	26
de-emphasis, Automatic.....	26
de-emphasis, CCITT.....	26

de-emphasis, recommendation	27
definitions.....	73
Delius, biography.....	4
Delius, music by.....	5
digital interface specifications.....	46
Disp menu.....	25
display blanking.....	26, 66
display brightness.....	26, 44
Display button, remote.....	44
display defaults.....	25
display test routine.....	31
display, Balance	38
display, main.....	38
display, Volume	38
displaying format	25
displaying sample rate.....	25
displaying selected input	25
displaying volume.....	25
do not swap Dual AES cables	24, 40
do not use with Dual AES.....	41
DSD	3, 41, 47, 50, 73
DSP-Err1 message.....	64
DSPs Not Loaded message	64
Dual AES	24, 38, 40, 47
Dual AES Auto mode fails	24
Dual AES cable match.....	24
Dual AES drop out.....	67
Dual AES input, selecting.....	11
Dual AES Lock mode	24
Dual AES menu	24
Dual AES Off	24
Dual AES On	24
Dual AES options	24
Dual AES problems	67
Dual AES requirements	24
Dual AES, Auto mode.....	24
Dual AES, do not swap cables	24, 40
Dual AES, do not use with.....	41
Dual AES, using	18
DVD player	3
DVD sample rate changes.....	68

E

earthing.....	56
emphasis message flag wrong.....	26

F

factory default settings.....	34
Factory menu.....	34
Fade in after re-lock.....	23
Fade menu.....	23
fade out time before mute.....	23
fade up time after mute.....	23
fails to respond	66
fault indication.....	64
Filter button, remote	44
Filter menu.....	21
Filter, anti-image.....	21
Filter, choosing	21

filter, energy smear	21, 44
Filter, interpolation	21
Filter, transient response	21
first-time use	56
flashing AES indicator.....	24
Found Track message.....	33
FPGAs Not Loaded message.....	64
Frederick Delius, biography	4
frequency response	47
front panel	36
Fs=??? message	22
full scale	73
Function button	38
Function button, remote.....	43
Function Menu	20
Function Menu, closing.....	20
Function Menu, opening	20
Function Menu, using.....	20
fuse, mains.....	60
fuse, replacing.....	60
fuse, spare	56

G

Global menu.....	27
grounding	56
guide to basic setup	10

H

hardware updates	62
hum pickup.....	40

I

IEEE 1394 interface.....	41, 50
IEEE 1394 interface option	58
Ignoring Non-Audio Flag message	29
Inactive message	69
indicator, input.....	38
indicator, MUTE	37
indicator, PHSE.....	37
indicator, PWR.....	37
indicator, Status	37
indicator, STBY	37
Input button	36
Input button, remote.....	44
input indicator.....	38
input selection	11, 36, 44
input selection, automatic	50
input, BNC.....	40
input, RCA.....	40
input, ST optical option	40
input, Toslink optical	40
input, Wordclock	41
inputs, AES	40
Issue menu	31
issue, software	31

J

jitter	28
jitter, low frequency.....	48

jitter, reducing41

L

learning remotes52
levels, analogue output25
lock failure65
lock-in time48
Locking message38, 68
locking problems28
Locking... message22
Loud message30
low audio problem65

M

main display26, 38
maintenance60
master clock41
master mode72
master mode limitations22
master mode with Upsampler22
master mode, lock failure65
master mode, PLL setting28
master mode, setting22
master mode, using14, 16, 17
Menu Select button20
Menu Step Back button20
Menu Step button20
menu time out20, 28
menu times out too soon28
menu, scrolling38, 44
message, Active69
message, Inactive69
message, Missing Wordclock between Clk Out
.....69
message, No Comms69
message, Please check source slaved to DAC
Wordclock Out69
message, Search69
message, Verdi Wordclock Missing69
message, Wrong Wordclock @ Verdi Clk In69
Missing Wordclock between Clk Out ...
message from DAC69
mode, master22
mode, slave22
mode, standby36
mono output65
MS menu22
music by Delius5
Mute button37
Mute button, remote44
mute fade time23
MUTE indicator37
Mute menu23
muting, automatic37
muting, Non-Audio37

N

NAud menu28
no audio output65

No Comms message 69
No Input message 37, 38
No Track message 33
noisy ST or Toslink input 67
Non Seq message 33
Nonaudio message 64
Non-Audio muting 28, 37, 64
Non-Audio muting, disable 29
Non-Audio muting, override 28
Non-Audio muting, restoring 29
normal display 25

O

one channel absent 66
opening the Function Menu 20
operating conditions 49
optical input is noisy 67
option, IEEE 1394 interface 58
option, supply voltage 58
options 58
options, changing 58
Out menu 25
output level, setting 13, 25
output, REC 41
output, Wordclock 41
outputs, balanced 39
outputs, unbalanced 40
oversampling 46

P

packaging 60
packaging, replacement 56
Ph.Check menu 29
Phase button, remote 44
phase check routine 29
phase locked loop 48
Phase menu 26
phase, changing 26
PHSE indicator 37
Please check source slaved to DAC Wordclock
Out message from DAC 69
Please Start CD message 33
PLL 67
PLL menu 28
PLL tracking bandwidth 28
positioning the unit 57
power amplifier, using 12
Power button 36
power inlet 42
power interruption 64
power off 36
power on 36
power requirements 49
power up failure 65
PowerDn message 36, 64
powering up 10
preamplifier, using 12, 38
pull-in range 48
Purcell button, remote 44

Purcell, controlling with remote44
PWR indicator.....37

R

RC5 codes52
RCA inputs.....40
rear panel.....39
REC output41
recommended recordings by Delius5
remote control.....43, 61
remote control codes52
remote control does not work68
remote control sensor.....37
remote control, replacing batteries61
resetting to factory state34
resetting to slave mode34
response is slow22
Revert to Slave message22
Ring DAC.....3, 46
Rotary Control.....38
Rst Sync menu34

S

safety56
safety, electrical63
sample clock48
sample rate9, 40, 41, 47, 73
SDIF-273
Search message.....69
Select button.....20, 38
selecting 1394 input.....11
selecting a single wire input.....11
selecting an input.....11
selecting Dual AES input11
Serial menu.....31
serial number, full31
serial number, short.....42
service60
setting output level.....13
setting, supply voltage57
settings after Factory reset34
size49
slave mode, resetting to34
slave mode, setting.....22
slow response.....66
software issue.....31
software update by CD32
software update fails.....68
software updates62
software upgrade connector41
software version72
source, synchronising to.....48
SPDIF40, 73
SPDIF input, selecting11
SPDIF inputs.....40
SPDIF output41
specification46
specification, AES3 I/O46
specification, analogue outputs48

specification, IEEE 1394 interface 46
specification, optical I/O 46
specification, SDIF / wordclock I/O 46
specification, SPDIF I/O 46
ST optical input option 40
Standby button, remote.....43
standby mode 36, 37, 43
Status indicator 36, 37
STBY indicator 37
Step Back button.....37
Step button.....20, 37
step-by-step guide 10
SUC connector.....41
supply voltage option 58
supply voltage setting 42, 57
swap channels 25, 29
Swap menu 25
swapped channels 66
sync to Wordclock In.....22
synchronising 1394 interface 50
system burn-in 30

T

technical notes 71
Temp menu.....31
temperature scale 31
temperature, internal.....31
temperature, operating.....49
Test menu31
time out43
Timeout menu28
tonal balance, peculiar66
Too Hot! message.....64
Toslink optical input40
Track n message33
troubleshooting 64, 65
troubleshooting 1394 interface 69

U

unbalanced outputs.....40
Up and Down buttons, remote44
updates 3, 42, 62
updates, hardware62
updates, software.....62
updating software by CD.....32
updating your Delius62
upgrader's note 39, 72
using Dual AES.....18
using for the first time.....56
using master mode 14, 16
using with Verdi.....16
using with Verdi and Purcell.....17, 18

V

VCXO48
Verdi Wordclock Missing message from DAC
.....69
Vol xx.x display38
Vol/Bal button, remote44

Volume.....	27, 38, 48
Volume display	38
Volume, global.....	27
Volume, local	27
Volume, per input	27
Vx.xx message	33

W

weight	49
Word Clock	73

Wordclock input	41
Wordclock output	41, 47
Wrong CD message.....	33
Wrong Wordclock @ Verdi Clk In message from DAC.....	69
Wrong! message.....	33

X

xxx%xxx% message	38
------------------------	----